

danish healthcare design

Typeliste / Typeliste / Typelist 2020

C+ Soft



Målskitse
 Maßzeichnung
 Dimensional drawing

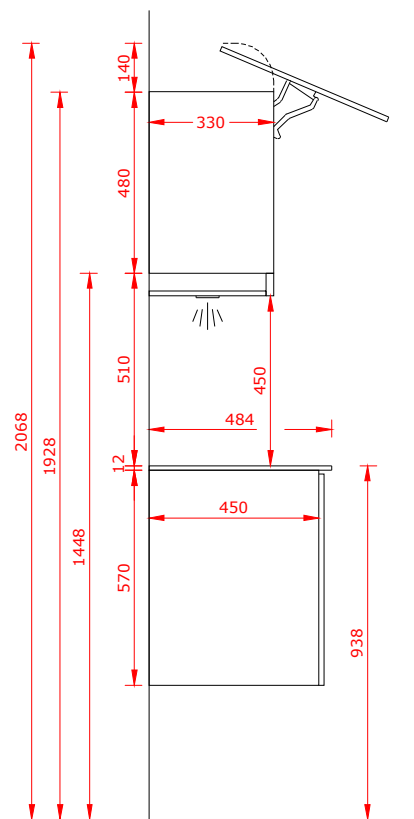
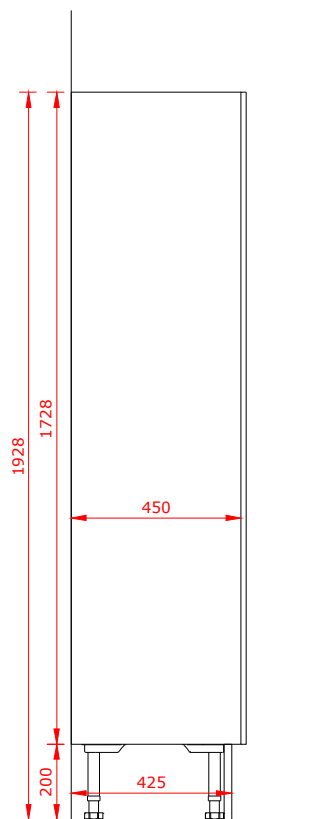
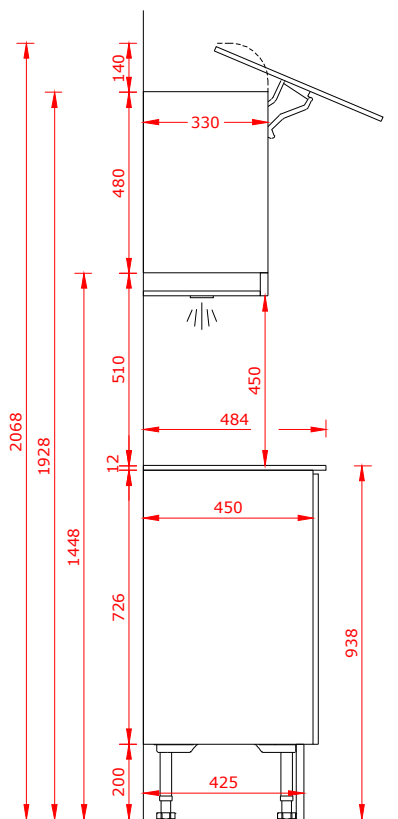

C+ Soft - Standard

C+ Soft - Kompakt

Klinikinventar

Praxismöbel

Floor cabinets 72,6

Varenr. Warennr. Article nr.	Beskrivelse / Beschreibung / Description	Mål i cm Mass Measure
Underskabe 72,6		
Unterschränke 72,6		
Floor cabinets 72,6		
CS7100	 <p>Skuffeskab, 9 skuffer 8 cm. Softclose skinner. Schubladenschrank, 9 Schubladen 8 cm. Softclose schienen. Cabinet with drawers, 9 drawers 8 cm. Softclose rails.</p>	<p>H 72,6 B 52,6 D/T 47</p>
CS7101	 <p>Skuffeskab, 7 skuffer 8 cm, 1 skuffe 16 cm. Softclose skinner. Schubladenschrank, 7 Schubladen 8 cm und 1 Schublade 16 cm. Softclose Schienen. Cabinet with drawers, 7 drawers 8 cm, 1 drawer 16 cm. Softclose rails.</p>	<p>H 72,6 B 52,6 D/T 47</p>
CS7102	 <p>Skuffeskab, 5 skuffer 8 cm, 2 skuffer 16 cm. Softclose skinner. Schubladenschrank, 5 Schubladen 8 cm und 2 Schubladen 16 cm. Softclose Schienen. Cabinet with drawers, 5 drawers 8 cm, 2 drawers 16 cm. Softclose rails.</p>	<p>H 72,6 B 52,6 D/T 47</p>
CS7103	 <p>Skuffeskab, 3 skuffer 8 cm, 3 skuffer 16 cm. Softclose skinner. Schubladenschrank, 3 Schubladen 8 cm und 3 Schubladen 16 cm. Softclose Schienen. Cabinet with drawers, 3 drawers 8 cm, 3 drawers 16 cm. Softclose rails.</p>	<p>H 72,6 B 52,6 D/T 47</p>
CS7104	 <p>Skuffeskab, 3 skuffer 8 cm, 1 skuffe 16 cm, 1 skuffe 32 cm. Softclose skinner. Schubladenschrank, 3 Schubladen 8 cm, 1 Schublade 16 cm und 1 Schublade 32 cm. Softclose Schienen. Cabinet with drawers, 3 drawers 8 cm, 1 drawer 16 cm, 1 drawer 32 cm. Softclose rails.</p>	<p>H 72,6 B 52,6 D/T 47</p>
CS7105	 <p>Skuffeskab, 1 skuffe 8 cm, 2 skuffer 16 cm, 1 skuffe 32 cm. Softclose skinner. Schubladenschrank, 1 Schublade 8 cm, 2 Schubladen 16 cm und 1 Schublade 32 cm. Softclose Schienen. Cabinet with drawers, 1 drawer 8 cm, 2 drawers 16 cm, 1 drawer 32 cm. Softclose rails.</p>	<p>H 72,6 B 52,6 D/T 47</p>
CS7106	 <p>Skuffeskab, 1 skuffe 8 cm, 4 skuffer 16 cm. Softclose skinner. Schubladenschrank, 1 Schublade 8 cm und 4 Schubladen 16 cm. Softclose Schienen. Cabinet with drawers, 1 drawer 8 cm, 4 drawers 16 cm. Softclose rails.</p>	<p>H 72,6 B 52,6 D/T 47</p>
CS7107	 <p>Skuffeskab m/tastaturudtræk, 7 skuffer 8 cm. Softclose skinner. Schubladenschrank m/Tastaturauszug, 7 Schubladen 8 cm. Softclose Schienen. Cabinet with pull-out plate for keyboard, 7 drawers 8 cm. Softclose rails.</p>	<p>H 72,6 B 52,6 D/T 47</p>

Klinikinventar

Praxismöbel

Varenr. Warennr. Article nr.	Beskrivelse / Beschreibung / Description	Mål i cm Mass Measure
CS7108	 <p>Skuffeskab m/tastaturudtræk, 5 skuffer 8 cm, 1 skuffe 16 cm. Softclose skinner. Schubladenschrank m/Tastaturauszug, 5 Schubladen 8 cm und 1 Schublade 16 cm. Softclose Schienen. Cabinet with pull-out plate for keyboard, 5 drawers 8 cm, 1 drawer 16 cm. Softclose rails.</p>	H 72,6 B 52,6 D/T 47
CS7109	 <p>Skuffeskab m/tastaturudtræk, 3 skuffer 8 cm, 2 skuffer 16 cm. Softclose skinner. Schubladenschrank m/Tastaturauszug, 3 Schubladen 8 cm und 2 Schubladen 16 cm. Softclose Schienen. Cabinet with pull-out plate for keyboard, 3 drawers 8 cm, 2 drawers 16 cm. Softclose rails.</p>	H 72,6 B 52,6 D/T 47
CS7110	 <p>Kombinationsskab, 2 skuffer 16 cm, 1 hylde, 1 dør højre- eller venstrehængt. Softclose skinner. Kombinerter Schrank, 2 Schubladen 16 cm, 1 Einlegeboden, 1 Tür rechts oder links angeschlagen. Softclose Schienen. Combination cabinet, 2 drawers 16 cm, 1 shelf, 1 door right or left. Softclose rails.</p>	H 72,6 B 52,6 D/T 47
CS7111	 <p>Kombinationsskab, 4 skuffer 8 cm, 1 hylde, 1 dør højre- eller venstrehængt. Softclose skinner. Kombinerter Schrank, 4 Schubladen 8 cm, 1 Einlegeboden, 1 Tür rechts oder links angeschlagen. Softclose Schienen. Combination cabinet, 4 drawers 8 cm, 1 shelf, 1 door right or left. Softclose rails.</p>	H 72,6 B 52,6 D/T 47
CS7112	 <p>Kombinationsskab, 1 skuffe 8 cm, åbent rum, 1 tastaturudtræk, 1 hylde, 1 dør højre- eller venstrehængt. Softclose skinner. Kombinerter Schrank, 1 Schublade 8 cm, Freiraum, 1 Tastaturauszug, 1 Einlegeboden, 1 Tür rechts oder links angeschlagen. Softclose Schienen. Combination cabinet, 1 drawer 8 cm, open space, 1 keyboard pull-out, 1 shelf, 1 door right or left. Softclose rails.</p>	H 72,6 B 52,6 D/T 47
CS7113	 <p>Udrøringssskab, udrøringsplade i laminat, 1 stikkontakt, 1 skuffe 16 cm, 1 skuffe 24 cm. Softclose skinner. Anmisch-Schrank, Anmischplatte in Laminat, 1 Steckdose. 1 Schublade 16 cm, 1 Schublade 24 cm. Softclose Schienen. Amalgamator cabinet, mixer plate in laminate, 1 socket, 1 drawer 16 cm, 1 drawer 24 cm. Softclose rails.</p>	H 72,6 B 52,6 D/T 47
CS7114	 <p>Universalskab m/indskydelig låge, udtræksplade til ekstra udstyr, 2 skuffer 16 cm. Softclose skinner. Universal-Schrank m/einschiebbarer Tür, 1 Auszug für Zusatzgeräte, 2 Schubladen 16 cm. Softclose Schienen. Universal cabinet with push-in door, 1 extension for additional equipment, 2 drawers 16 cm. Softclose rails.</p>	H 72,6 B 52,6 D/T 47
CS7200	 <p>Skab for PC, indskydelig dør højre- eller venstrehængt. Schrank für PC, 1 Einschiebbare Tür rechts oder links angeschlagen. Cabinet for PC, 1 Push-in door right or left.</p>	H 72,6 B 32,6 D/T 47
CS7201	 <p>Skab for PC, 1 jalousilåge. Schrank für PC, 1 Rolladentür. Cabinet for PC, 1 Roll front.</p>	H 72,6 B 32,6 D/T 47





Klinikinventar

Praxismöbel

Varenr. Warennr. Article nr.	Beskrivelse / Beschreibung / Description	Mål i cm Mass Measure
CS7202	 <p>Opbevaringsskab m/1 hylde, 1 dør højre- eller venstrehængt. Aufbewahrungs-Schrank, 1 Einlegeboden, 1 Tür rechts oder links angeschlagen. Storage cabinet, 1 shelf, 1 door right or left.</p>	<p>H 72,6 B 32,6 D/T 47</p>
CS7203	 <p>Opbevaringsskab m/1 hylde, 1 dør højre- eller venstrehængt. Aufbewahrungs-Schrank, 1 Einlegeboden, 1 Tür rechts oder links angeschlagen. Storage cabinet, 1 shelf, 1 door right or left.</p>	<p>H 72,6 B 42,6 D/T 47</p>
CS7204	 <p>Opbevaringsskab m/1 hylde, 1 dør højre- eller venstrehængt. Aufbewahrungs-Schrank, 1 Einlegeboden, 1 Tür rechts oder links angeschlagen. Storage cabinet, 1 shelf, 1 door right or left.</p>	<p>H 72,6 B 52,6 D/T 47</p>
CS7205	 <p>Opbevaringsskab m/1 hylde, 1 dør højre- eller venstrehængt. Aufbewahrungs-Schrank, 1 Einlegeboden, 1 Tür rechts oder links angeschlagen. Storage cabinet, 1 shelf, 1 door right or left.</p>	<p>H 72,6 B 62,6 D/T 47</p>
CS7206	 <p>Kassetteskab for 10 bakker m/låg, 1 indskydelig dør højre- eller venstrehængt. Tray-Schrank für 10 Normtrays mit Deckel, 1 einschiebbare Tür rechts oder links angeschlagen. Instrument tray cabinet for 10 trays with cover, 1 push-in door right or left.</p>	<p>H 72,6 B 32,6 D/T 47</p>
CS7207	 <p>Kassetteskab for 20 bakker u/låg, 1 indskydelig dør højre- eller venstrehængt. Tray-Schrank für 20 Normtrays ohne Deckel, 1 einschiebbare Tür rechts oder links angeschlagen. Instrument tray cabinet for 20 trays without cover, 1 push-in door right or left.</p>	<p>H 72,6 B 32,6 D/T 47</p>
CS7300	 <p>Vaskeskab, 1 blænde, 1 dør højre- eller venstrehængt. Waschbeckenschrank, 1 Blende oben, 1 Tür rechts oder links angeschlagen. Cabinet for sink, adjusting panel, 1 door right or left.</p>	<p>H 72,6 B 52,6 D/T 47</p>
CS7301	 <p>Vaskeskab, 1 affaldsklap, 1 dør højre- eller venstrehængt. Waschbeckenschrank, 1 Abfallklappe, 1 Tür rechts oder links angeschlagen. Cabinet for sink, 1 waste compartment, 1 door right or left.</p>	<p>H 72,6 B 52,6 D/T 47</p>
CS7302	 <p>Vaskeskab m/fodbetjent affaldsklap, 1 dør højre- eller venstrehængt. Waschbeckenschrank, 1 fussbediente Abfallklappe, 1 Tür rechts oder links angeschlagen. Cabinet for sink, 1 foot operated flap for waste, 1 door right or left.</p>	<p>H 72,6 B 52,6 D/T 47</p>
CS7303	 <p>Vaskeskab m/selvåbnende udtræk. Elektronisk styring. Waschbeckenschrank, selbstöffnender Auszug. Elektronische Steuerung. Cabinet for sink, 1 automatic extension for waste. Electronic control.</p>	<p>H 72,6 B 52,6 D/T 47</p>

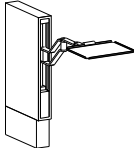
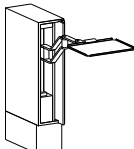
Klinikinventar

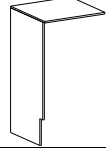
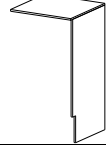
Praxismöbel

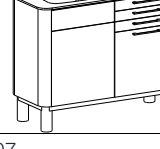
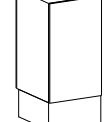
Varenr. Warennr. Article nr.	Beskrivelse / Beschreibung / Description	Mål i cm Mass Measure
CS7400	 <p>Højdejusterbart håndinstrumentbord monteret i 10 cm bredt skab. (72-106 cm) Höhenverstellbarer Handinstrumententisch im Schrank eingebaut, 10 cm breit. (72-106 cm) Height adjustable hand instrument table mounted in 10 cm wide cabinet. (72-106 cm)</p>	<p>H 72,6 B 10 D/T 47</p>
CS7401	 <p>Højdejusterbart håndinstrumentbord monteret i 20 cm bredt skab. (72-106 cm). 1 dør højre- eller venstrehængt. Höhenverstellbarer Handinstrumententisch im Schrank eingebaut, 20 cm breit. (72-106 cm). 1 Tür rechts oder links angeschlagen. Height adjustable hand instrument table mounted in 20 cm wide cabinet. (72-106 cm). 1 door right or left.</p>	<p>H 72,6 B 20 D/T 47</p>
CS7500	 <p>Venstre tilpasningsstykke, incl. frontbeklædning. Linke Blende/Passtück mit Frontverkleidung. Left front adjusting panel incl. frontcovering.</p>	<p>H 72,6 B D/T</p>
CS7501	 <p>Højre tilpasningsstykke, incl. frontbeklædning. Rechte Blende/Passtück mit Frontverkleidung. Right front adjusting panel incl. frontcovering.</p>	<p>H 72,6 B D/T</p>
CS7502	 <p>Venstre støttegavl. Stützwange links. Left support end.</p>	<p>H 92,6 B D/T 47</p>
CS7503	 <p>Højre støttegavl. Stützwange rechts. Right support end.</p>	<p>H 92,6 B D/T 47</p>
CS7504	 <p>Venstre sidebeklædning. Seitenverkleidung links. Left end panel.</p>	<p>H 72,6 B D/T 47</p>
CS7505	 <p>Højre sidebeklædning. Seitenverkleidung rechts. Right end panel.</p>	<p>H 72,6 B D/T 47</p>
CS7506	 <p>Gavl med afrundede hjørner. Giebel m/abgerundet Ecken. End gable with rounded corners.</p>	<p>H 72,6 B 7 D/T 47</p>
CS7507	 <p>Bagsidebeklædning. Rückwandverkleidung. Back covering.</p>	<p>H 72,6 B 42,6 D/T</p>

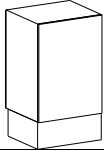
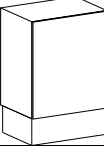
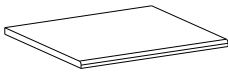
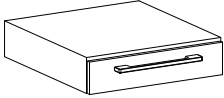
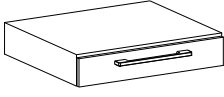
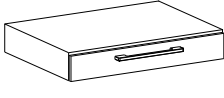
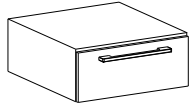
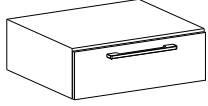
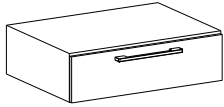
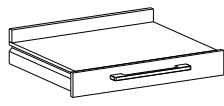

Klinikinventar

Praxismöbel

Varenr. Warennr. Article nr.	Beskrivelse / Beschreibung / Description	Mål i cm Mass Measure
CS7508	 <p>Bagsidebeklædning. Rückwandverkleidung. Back covering.</p>	<p>H 72,6 B 52,6 D/T</p>
CS7509	 <p>Bagsidebeklædning. Rückwandverkleidung. Back covering.</p>	<p>H 72,6 B 62,6 D/T</p>
CS7510	 <p>Udtræksplade på skinner. Ausziehbare Platte auf Schienen. Pull-out plate.</p>	<p>H B D/T</p>
CS7600	 <p>8 cm skuffekabinet. Softclose skinner. 8 cm Schubladenschrank. Softclose Schienen. 8 cm drawer cabinet. Softclose rails.</p>	<p>H 8 B 42,6 D/T 47</p>
CS7601	 <p>8 cm skuffekabinet. Softclose skinner. 8 cm Schubladenschrank. Softclose Schienen. 8 cm drawer cabinet. Softclose rails.</p>	<p>H 8 B 52,6 D/T 47</p>
CS7602	 <p>8 cm skuffekabinet. Softclose skinner. 8 cm Schubladenschrank. Softclose Schienen. 8 cm drawer cabinet. Softclose rails.</p>	<p>H 8 B 62,6 D/T 47</p>
CS7603	 <p>16 cm skuffekabinet. Softclose skinner. 16 cm Schubladenschrank. Softclose Schienen. 16 cm drawer cabinet. Softclose rails.</p>	<p>H 16 B 42,6 D/T 47</p>
CS7604	 <p>16 cm skuffekabinet. Softclose skinner. 16 cm Schubladenschrank. Softclose Schienen. 16 cm drawer cabinet. Softclose rails.</p>	<p>H 16 B 52,6 D/T 47</p>
CS7605	 <p>16 cm skuffekabinet. Softclose skinner. 16 cm Schubladenschrank. Softclose Schienen. 16 cm drawer cabinet. Softclose rails.</p>	<p>H 16 B 62,6 D/T 47</p>
CS7606	 <p>Tastatur-udtræk i skuffeskab. Softclose skinner. Ausziehbare Platte für die Tastatur, im Schubladenschrank eingebaut. Softclose Schienen. Pull-out plate for keyboard, built-in cabinet for drawers. Softclose rails.</p>	<p>H 8 B 52,6 D/T 47</p>

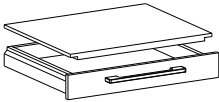
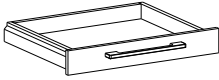
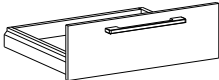
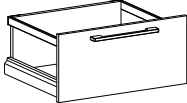
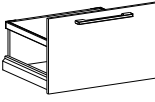
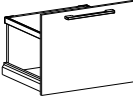
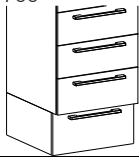
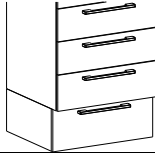
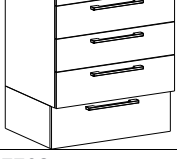

Klinikinventar

Praxismöbel

Varenr. Warennr. Article nr.	Beskrivelse / Beschreibung / Description	Mål i cm Mass Measure
CS7607	 <p>Skriveplade til skuffe. Schreibplatte für Schublade. Pull out plate for drawer.</p>	<p>H</p> <p>B 52,6</p> <p>D/T 47</p>
CS7608	 <p>8 cm skuffe. Softclose skinner. 8 cm Schublade. Softclose Schienen. 8 cm drawer. Softclose rails.</p>	<p>H 8</p> <p>B 52,6</p> <p>D/T 47</p>
CS7609	 <p>16 cm skuffe. Softclose skinner. 16 cm Schublade. Softclose Schienen. 16 cm drawer. Softclose rails.</p>	<p>H 16</p> <p>B 52,6</p> <p>D/T 47</p>
CS7610	 <p>24 cm skuffe. Softclose skinner. 24 cm Schublade. Softclose Schienen. 24 cm drawer. Softclose rails.</p>	<p>H 24</p> <p>B 52,6</p> <p>D/T 47</p>
CS7611	 <p>32 cm skuffe. Softclose skinner. 32 cm Schublade. Softclose Schienen. 32 cm drawer. Softclose rails.</p>	<p>H 32</p> <p>B 52,6</p> <p>D/T 47</p>
CS7612	 <p>40 cm skuffe. Softclose skinner. 40 cm Schublade. Softclose Schienen. 40 cm drawer. Softclose rails.</p>	<p>H 40</p> <p>B 52,6</p> <p>D/T 47</p>
CS7700	 <p>Sokkelskuffe. Sockelschublade. Plinth drawer.</p>	<p>H 20</p> <p>B 42,6</p> <p>D/T 47</p>
CS7701	 <p>Sokkelskuffe. Sockelschublade. Plinth drawer.</p>	<p>H 20</p> <p>B 52,6</p> <p>D/T 47</p>
CS7702	 <p>Sokkelskuffe. Sockelschublade. Plinth drawer.</p>	<p>H 20</p> <p>B 62,6</p> <p>D/T 47</p>
CS7703	 <p>Sokkel i fugtbestandig melamin, pr. m. Sockel in feuchtigkeitsbeständig Melamin, pro m. Plinth in moisture resistant melamine, per m.</p>	<p>H 20</p> <p>B</p> <p>D/T</p>



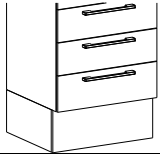
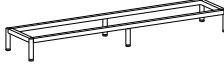

Klinikinventar

Praxismöbel

Varenr. Warennr. Article nr.	Beskrivelse / Beschreibung / Description	Mål i cm Mass Measure
CS7704	 <p>Sokkel i laminat, pr. m. Sockel in Laminat, pro m. Plinth in laminate, per m.</p>	H 20 B D/T
CS7705	 <p>Sokkel i aluminiumslaminat, pr. m. Sockel in Aluminium-Laminat, pro m. Plinth in aluminum laminate, per m.</p>	H 20 B D/T
CS7706	 <p>Ramme for fritstående skabe, EFTER TILBUD. Rahmen für freistehende Schränke, NUR AUF NACHFRAGE. Frame for freestanding cabinets, ACCORDING TO OFFER.</p>	H B D/T
MSV1	 <p>Megaspace modul. Front i Højglans laminat. Sokkel i 9510 Børstet Aluminium. Greb i 320 mm POOL Krom. Bordplade i HIMACS Solid Farvegruppe. Kabelgennemføringer i børstet stål. Inkl. 1 stk. lille bakke. Eks. Tastatur. Megaspace modul. Fronten in Hochglanz Laminat. Sockel in 9510 Gebürstet Aluminium. Griffe 320 mm POOL in Krom. Arbeitsplatte in HIMACS Solid color. Kabeldurchlss in Edelstahl. Inkl. Handinstrument Tisch, exkl. Tastatur Megaspace module. Front in glossy laminate. Plinth in M9510 Brushed Aluminum. Handles in 320 mm POOL Chrome. Worktop in HIMACS Solid Color. Cable passage in Brushed Steel. Incl. 1 small tray. Excl. Keyboard.</p>	H B D/T
MSV2	 <p>Megaspace modul. Front i 1025 Hvid laminat. Sokkel i Hvid melamin. Greb i 320 mm Aluminium. Bordplade i 12 mm kompaktlaminat. Kabelgennemføringer i børstet stål. Inkl. 1 stk. lille bakke. Eks. Tastatur. Megaspace Modul. Fronten in 1025 Weiss Laminat. Sockel in Weiss Melamin. Griffe in 320 mm Aluminium. Arbeitsplatte in 12 mm Kompakt Laminat. Kabeldurchlss in Edelstahl. Inkl. Handinstrument Tisch, exkl. Tastatur Megaspace module. Front in 1025 White Laminate. Plinth in White Melamine. Handles in 320 mm Aluminum. Worktop 1025 White Compact Laminate. Cable passage in Brushed Steel. Incl. 1 small tray. Excl. Keyboard.</p>	H B D/T

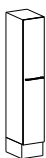
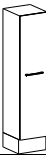
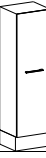
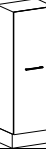





Klinikinventar

Praxismöbel

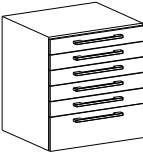
Varenr. Warennr. Article nr.	Beskrivelse / Beschreibung / Description	Mål i cm Mass Measure
Højskabe klinik	Hochschränke Behandlung	High cabinets Clinic
CH2100	 <p>Højt skab m/4 hylder, 1 dør højre- eller venstrehængt. Hochschrank m/4 Einlegeböden, 1 Tür rechts oder links angeschlagen. High storage cabinet w/4 shelves, 1 door right or left.</p>	<p>H 172,8 B 32,6 D/T 47</p>
CH2101	 <p>Højt skab m/4 hylder, 1 dør højre- eller venstrehængt. Hochschrank m/4 Einlegeböden, 1 Tür rechts oder links angeschlagen. High storage cabinet w/4 shelves, 1 door right or left.</p>	<p>H 172,8 B 42,6 D/T 47</p>
CH2102	 <p>Højt skab m/4 hylder, 1 dør højre- eller venstrehængt. Hochschrank m/4 Einlegeböden, 1 Tür rechts oder links angeschlagen. High storage cabinet w/4 shelves, 1 door right or left.</p>	<p>H 172,8 B 52,6 D/T 47</p>
CH2103	 <p>Højt skab m/4 hylder, 1 dør højre- eller venstrehængt. Hochschrank m/4 Einlegeböden, 1 Tür rechts oder links angeschlagen. High storage cabinet w/4 shelves, 1 door right or left.</p>	<p>H 172,8 B 62,6 D/T 47</p>
CH2200	 <p>Venstre tilpasningsstykke, incl. frontbeklædning. Linke Blende/Passtück mit Frontverkleidung. Left front adjusting panel incl. frontcovering.</p>	<p>H 172,8 B D/T</p>
CH2201	 <p>Højre tilpasningsstykke, incl. frontbeklædning. Rechte Blende/Passtück mit Frontverkleidung. Right front adjusting panel incl. frontcovering.</p>	<p>H 172,8 B D/T</p>
CH2202	 <p>Venstre sidebeklædning. Seitenverkleidung links. Left end panel.</p>	<p>H 172,8 B D/T 47</p>
CH2203	 <p>Højre sidebeklædning. Seitenverkleidung rechts. Right end panel.</p>	<p>H 172,8 B D/T 47</p>

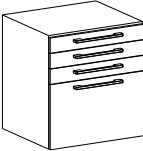

Klinikinventar

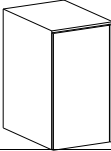
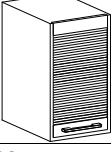
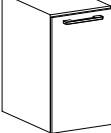
Praxismöbel

Varenr. Warennr. Article nr.	Beskrivelse / Beschreibung / Description	Mål i cm Mass Measure
Underskabe 57,0	Unterschränke 57,0	Floor cabinets 57,0
CS6100	 <p>Skuffeskab, 5 skuffer 8 cm, 1 skuffe 16 cm. Softclose skinner. Schubladenschrank, 5 Schubladen 8 cm und 1 Schublade 16 cm. Softclose Schienen. Cabinet with drawers, 5 drawers 8 cm, 1 drawer 16 cm. Softclose rails.</p>	H 57 B 52,6 D/T 47
CS6101	 <p>Skuffeskab m/tastaturudtræk, 3 skuffer 8 cm, 1 skuffe 16 cm. Softclose skinner. Schubladenschrank m/Tastaturauszug, 3 Schubladen 8 cm, 1 Schublade 16 cm. Softclose Schienen. Cabinet with pull-out plate for keyboard, 3 drawers 8 cm, 1 drawer 16 cm. Softclose rails.</p>	H 57 B 52,6 D/T 47
CS6102	 <p>Skuffeskab, 3 skuffer 8 cm, 2 skuffer 16 cm. Softclose skinner. Schubladenschrank, 3 Schubladen 8 cm und 2 Schubladen 16 cm. Softclose Schienen. Cabinet with drawers, 3 drawers 8 cm, 2 drawers 16 cm. Softclose rails.</p>	H 57 B 52,6 D/T 47
CS6103	 <p>Skuffeskab m/tastaturudtræk, 1 skuffe 8 cm, 2 skuffer 16 cm. Softclose skinner. Schubladenschrank m/Tastaturauszug, 1 Schublade 8 cm, 2 Schubladen 16 cm. Softclose schienen. Cabinet with pull-out plate for keyboard, 1 drawer 8 cm, 2 drawers 16 cm. Softclose rails.</p>	H 57 B 52,6 D/T 47
CS6104	 <p>Skuffeskab, 3 skuffer 8 cm, 1 skuffe 32 cm. Softclose skinner. Schubladenschrank, 3 Schubladen 8 cm und 1 Schublade 32 cm. Softclose Schienen. Cabinet with drawers, 3 drawers 8 cm, 1 drawer 32 cm. Softclose rails.</p>	H 57 B 52,6 D/T 47
CS6105	 <p>Skuffeskab m/tastaturudtræk, 1 skuffe 8 cm, 1 skuffe 24 cm. Softclose skinner. Schubladenschrank m/Tastaturauszug, 1 Schublade 8 cm, 1 Schublade 24 cm. Softclose Schienen. Cabinet with pull-out plate for keyboard, 1 drawer 8 cm, 1 drawer 24 cm. Softclose rails.</p>	H 57 B 52,6 D/T 47
CS6200	 <p>Skab for PC, 1 indskydelig dør højre- eller venstrehængt. Schränk für PC, 1 Einschiebbare Tür rechts oder links angeschlagen. Cabinet for PC, 1 push-in door right or left.</p>	H 57 B 32,6 D/T 47
CS6201	 <p>Skab for PC, 1 jalousilåge. Schränk für PC, 1 Rolladentür. Cabinet for PC, 1 roll front.</p>	H 57 B 32,6 D/T 47
CS6202	 <p>Opbevaringsskab m/1 hylde, 1 dør højre- eller venstrehængt. Aufbewahrungs-Schränk, 1 Einlegeboden, 1 Tür rechts oder links angeschlagen. Storage cabinet, 1 shelf, 1 door right or left.</p>	H 57 B 32,6 D/T 47

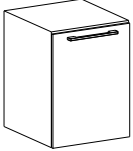
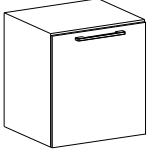
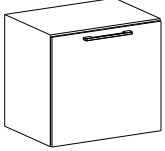
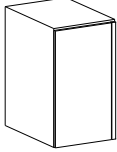
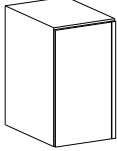
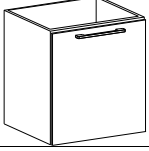
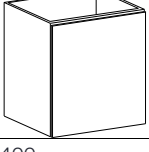
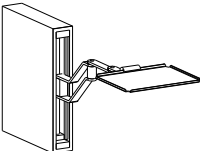
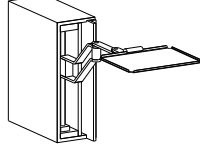

Klinikinventar

Praxismöbel

Varenr. Warennr. Article nr.	Beskrivelse / Beschreibung / Description	Mål i cm Mass Measure
CS6203	 <p>Opbevaringsskab m/1 hylde, 1 dør højre- eller venstrehængt. Aufbewahrungs-Schrank, 1 Einlegeboden, 1 Tür rechts oder links angeschlagen. Storage cabinet, 1 shelf, 1 door right or left.</p>	H 57 B 42,6 D/T 47
CS6204	 <p>Opbevaringsskab m/1 hylde, 1 dør højre- eller venstrehængt. Aufbewahrungs-Schrank, 1 Einlegeboden, 1 Tür rechts oder links angeschlagen. Storage cabinet, 1 shelf, 1 door right or left.</p>	H 57 B 52,6 D/T 47
CS6205	 <p>Opbevaringsskab m/1 hylde, 1 dør højre- eller venstrehængt. Aufbewahrungs-Schrank, 1 Einlegeboden, 1 Tür rechts oder links angeschlagen. Storage cabinet, 1 shelf, 1 door right or left.</p>	H 57 B 62,6 D/T 47
CS6206	 <p>Kassetteskab for 8 bakker m/låg, 1 indskydelig dør højre- eller venstrehængt. Tray-Schrank für 8 Normtrays mit Deckel, 1 einschiebbare Tür rechts oder links angeschlagen. Instrument tray cabinet for 8 trays with cover, 1 push-in door left or right.</p>	H 57 B 32,6 D/T 47
CS6207	 <p>Kassetteskab for 16 bakker u/låg, indskydelig dør højre- eller venstrehængt. Tray-Schrank für 16 Normtrays ohne Deckel, 1 einschiebbare Tür rechts oder links angeschlagen. Instrument tray cabinet for 16 trays with cover, 1 push-in door left or right.</p>	H 57 B 32,6 D/T 47
CS6300	 <p>Vaskeskab, 1 dør højre- eller venstrehængt. Waschbeckenschrank, 1 Tür rechts oder links angeschlagen. Cabinet for sink, 1 door right or left.</p>	H 57 B 52,6 D/T 47
CS6301	 <p>Vaskeskab m/selvåbnende udtræk, elektronisk styring Waschbeckenschrank, selbstöffnender Auszug. Elektronische Steuerung. Cabinet for sink, 1 automatic extension for waste. Electronic control.</p>	H 57 B 52,6 D/T 47
CS6400	 <p>Højdejusterbart håndinstrumentbord monteret i 10 cm bredt skab. Höhenverstellbarer Handinstrumententisch im Schrank eingebaut, 10 cm breit. Height adjustable hand instrument table mounted in 10 cm wide cabinet.</p>	H 57 B 10 D/T 47
CS6401	 <p>Højdejusterbart håndinstrumentbord monteret i 20 cm bredt skab. 1 dør højre- eller venstrehængt. Höhenverstellbarer Handinstrumententisch im Schrank eingebaut, 20 cm breit. 1 Tür rechts oder links angeschlagen. Height adjustable hand instrument table mounted in 20 cm wide cabinet. 1 door right or left.</p>	H 57 B 20 D/T 47
CS6500	 <p>Venstre tilpasningsstykke incl. frontbeklædning. Linke Blende/Passtück mit Frontverkleidung. Left front adjusting panel incl. frontcovering.</p>	H 57 B 10 D/T

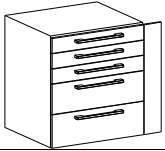

Klinikinventar

Praxismöbel

Varenr. Warennr. Article nr.	Beskrivelse / Beschreibung / Description	Mål i cm Mass Measure
CS6501	 <p>Højre tilpasningsstykke incl. frontbeklædning. Rechte Blende/Passtück mit Frontverkleidung. Right front adjusting panel incl. frontcovering.</p>	<p>H 57 B 10 D/T</p>
CS6502	 <p>Venstre sidebeklædning Seitenverkleidung links. Left end panel.</p>	<p>H 57 B 1,4 D/T 47</p>
CS6503	 <p>Højre sidebeklædning Seitenverkleidung rechts. Right end panel.</p>	<p>H 57 B 1,4 D/T 47</p>

Klinikinventar

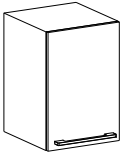
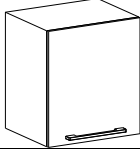
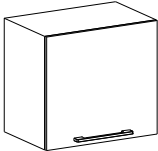
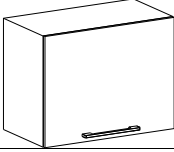
Praxismöbel

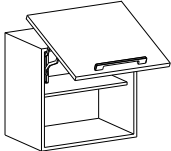
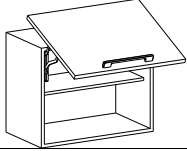
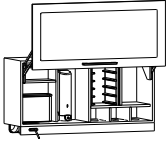
Varenr. Warennr. Article nr.	Beskrivelse / Beschreibung / Description	Mål i cm Mass Measure
Vægskabe	Wandschränke	Wall cabinets
CV5100	 <p>Vægskab m/1 hylde, 1 dør højre- eller venstrehængt. Oberschrank, 1 Einlegeboden, 1 Tür rechts oder links angeschlagen. Storage cabinet, 1 shelf, 1 door right or left.</p>	<p>H 48 B 32,6 D/T 35</p>
CV5101	 <p>Vægskab m/1 hylde, 1 dør højre- eller venstrehængt. Oberschrank, 1 Einlegeboden, 1 Tür rechts oder links angeschlagen. Storage cabinet, 1 shelf, 1 door right or left.</p>	<p>H 48 B 42,6 D/T 35</p>
CV5102	 <p>Vægskab m/1 hylde, 1 dør højre- eller venstrehængt. Oberschrank, 1 Einlegeboden, 1 Tür rechts oder links angeschlagen. Storage cabinet, 1 shelf, 1 door right or left.</p>	<p>H 48 B 52,6 D/T 35</p>
CV5103	 <p>Vægskab m/1 hylde, 1 dør højre- eller venstrehængt. Oberschrank, 1 Einlegeboden, 1 Tür rechts oder links angeschlagen. Storage cabinet, 1 shelf, 1 door right or left.</p>	<p>H 48 B 62,6 D/T 35</p>
CV5200	 <p>Vægskab m/1 hylde, 1 hævedør. Oberschrank, 1 Einlegeboden, 1 Hebetür. Wall cabinet, 1 shelf, 1 lift-up door.</p>	<p>H 48 B 32,6 D/T 35</p>
CV5201	 <p>Vægskab m/1 hylde, 1 hævedør. Oberschrank, 1 Einlegeboden, 1 Hebetür. Wall cabinet, 1 shelf, 1 lift-up door.</p>	<p>H 48 B 42,6 D/T 35</p>
CV5202	 <p>Vægskab m/1 hylde, 1 hævedør. Oberschrank, 1 Einlegeboden, 1 Hebetür. Wall cabinet, 1 shelf, 1 lift-up door.</p>	<p>H 48 B 52,6 D/T 35</p>
CV5203	 <p>Vægskab m/1 hylde, 1 hævedør. Oberschrank, 1 Einlegeboden, 1 Hebetür. Wall cabinet, 1 shelf, 1 lift-up door.</p>	<p>H 48 B 62,6 D/T 35</p>
CV5204	 <p>Vægskab m/hejselåge. 1 dobbelt dispenser for sæbe og desinfektionsmiddel, 1 servietdispenser, 1 hylde, 1 krusdispenser, indsats for 5 bakker m/låg, 3 huller for handsker eller mundbind. Wandschrank mit Hebetür. 1 spender für Seife und Desinfektionsmittel, 1 Handtuchspender, 1 Einlegeboden, 1 Spender für Becher, Einsatz für 5 Trays mit Deckel, 3 Löcher für Handschuh oder Mundschutz. Wall cabinet with lift-up door. 1 dispenser for soap and disinfection, 1 dispenser for tissues, 1 shelf, 1 dispenser for cups, insert for 5 trays with cover, 3 openings for gloves or facemasks.</p>	<p>H 48 B 105,2 D/T 35</p>

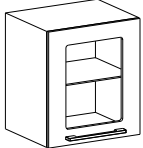
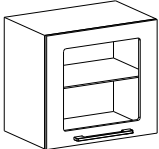
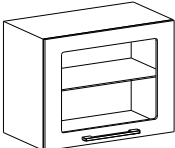
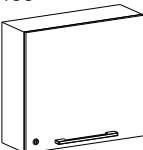
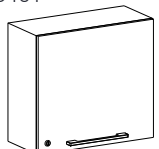
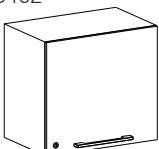
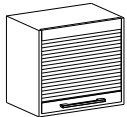
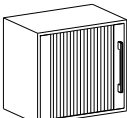
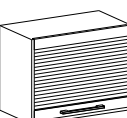
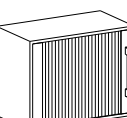

Klinikinventar

Praxismöbel

Varenr. Warennr. Article nr.	Beskrivelse / Beschreibung / Description	Mål i cm Mass Measure
CV5300	 <p>Vitrineskab m/1 glashylde, 1 vitrinelåge højre- eller venstrehængt. Oberschrank, 1 Glass-Einlegeboden, 1 Vitrinen Tür rechts oder links angeschlagen. Glass cabinet w/1 glass shelf, 1 glassdoor right or left.</p>	<p>H 48 B 42,6 D/T 35</p>
CV5301	 <p>Vitrineskab m/1 glashylde, 1 vitrinelåge højre- eller venstrehængt. Oberschrank, 1 Glass-Einlegeboden, 1 Vitrinen Tür rechts oder links angeschlagen. Glass cabinet w/1 glass shelf, 1 glassdoor right or left.</p>	<p>H 48 B 52,6 D/T 35</p>
CV5302	 <p>Vitrineskab m/1 glashylde, 1 vitrinelåge højre- eller venstrehængt. Oberschrank, 1 Glass-Einlegeboden, 1 Vitrinen Tür rechts oder links angeschlagen. Glass cabinet w/1 glass shelf, 1 glassdoor right or left.</p>	<p>H 48 B 62,6 D/T 35</p>
CV5400	 <p>Medicinskab m/2 glashylder, 1 dør højre- eller venstrehængt, 1 lås. Medikamentenschrank mit 2 Glass - Einlegeböden, 1 Tür rechts oder links angeschlagen, 1 Schloss. Medicine cabinet w/2 glass shelves, 1 door right or left, 1 lock.</p>	<p>H 48 B 52,6 D/T 19</p>
CV5401	 <p>Medicinskab m/2 glashylder, 1 dør højre- eller venstrehængt, 1 lås. Medikamentenschrank mit 2 Glass - Einlegeböden, 1 Tür rechts oder links angeschlagen, 1 Schloss. Medicine cabinet w/2 glass shelves, 1 door right or left, 1 lock.</p>	<p>H 48 B 52,6 D/T 24</p>
CV5402	 <p>Medicinskab m/2 glashylder, 1 dør højre- eller venstrehængt, 1 lås. Medikamentenschrank mit 2 Glass - Einlegeböden, 1 Tür rechts oder links angeschlagen, 1 Schloss. Medicine cabinet w/2 glass shelves, 1 door right or left, 1 lock.</p>	<p>H 48 B 52,6 D/T 35</p>
CV5500	 <p>Vægskab m/1 hylde, 1 vandret jalousidør. Oberschrank, 1 Einlegeboden, 1 horizontal Rolladentür. Storage cabinet with 1 shelf, 1 horisontal roll-front.</p>	<p>H 48 B 52,6 D/T 35</p>
CV5501	 <p>Vægskab m/1 hylde, 1 lodret jalousidør. Oberschrank, 1 Einlegeboden, 1 senkrecht Rolladentür. Storage cabinet with 1 shelf, 1 vertical roll-front.</p>	<p>H 48 B 52,6 D/T 35</p>
CV5502	 <p>Vægskab m/1 hylde, 1 vandret jalousidør. Oberschrank, 1 Einlegeboden, 1 horizontal Rolladentür. Storage cabinet with 1 shelf, 1 horisontal roll-front.</p>	<p>H 48 B 62,6 D/T 35</p>
CV5503	 <p>Vægskab m/1 hylde, 1 lodret jalousidør. Oberschrank, 1 Einlegeboden, 1 senkrecht Rolladentür. Storage cabinet with 1 shelf, 1 vertical roll-front.</p>	<p>H 48 B 62,6 D/T 35</p>

Klinikinventar

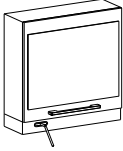
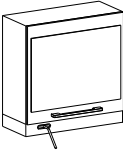
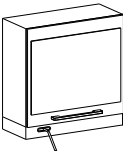
Praxismöbel

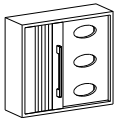
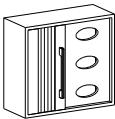
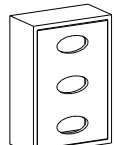
Varenr. Warennr. Article nr.	Beskrivelse / Beschreibung / Description	Mål i cm Mass Measure
CV5600	 <p>Dispenserskab med spejl, 1 dobbelt dispenser til sæbe og desinfektionsmiddel, 1 servietdispenser, 1 dør højre- eller venstrehængt. Spender-Schrank m/Spiegel, 1 Doppelspender für Seife und Desinfektionsmittel, 1 Handtuchspender, 1 Tür rechts oder links angeschlagen. Dispenser cabinet with mirror, 1 double dispenser for soap and disinfectant, 1 tissue dispenser, 1 door right or left.</p>	H 48 B 52,6 D/T 19
CV5601	 <p>Dispenserskab med spejl, 1 dobbelt dispenser til sæbe og desinfektionsmiddel, 1 papirulledispenser, 1 dør højre- eller venstrehængt. Spender-Schrank m/Spiegel, 1 Doppelspender für Seife und Desinfektionsmittel, 1 Papierrollenspender, 1 Tür rechts oder links angeschlagen. Dispenser cabinet with mirror, 1 double dispenser for soap and disinfectant, 1 dispenser for roll of paper, 1 door right or left.</p>	H 48 B 52,6 D/T 24
CV5602	 <p>Dispenserskab med spejl, 1 dobbelt dispenser til sæbe og desinfektionsmiddel, 1 papirulledispenser, 1 krusdispenser, 1 dør højre- eller venstrehængt. Spender-Schrank m/Spiegel, 1 Doppelspender für Seife und Desinfektionsmittel, 1 Papierrollenspender, 1 Spender für Becher, 1 Tür rechts oder links angeschlagen. Dispenser cabinet with mirror, 1 double dispenser for soap and disinfectant, 1 dispenser for roll of paper, 1 dispenser for cups, 1 door right or left.</p>	H 48 B 52,6 D/T 24
CV5603	 <p>Dispenserskab, 1 dobbelt dispenser til sæbe og desinfektionsmiddel, 2 huller for handsker, 1 hul for mundbind, 1 dør højre- eller venstrehængt. Spender-Schrank, 1 Doppelspender für Seife und Desinfektionsmittel, 2 Löcher für Handschuhe, 1 Loch für Mundschutz, 1 Tür rechts oder links angeschlagen. Dispenser cabinet, 1 double dispenser for soap and disinfectant, 2 openings for gloves, 1 opening for face masks, 1 door right or left.</p>	H 48 B 52,6 D/T 19
CV5700	 <p>Handskedispenser, 2 huller for handsker, 1 hul for mundbind, 1 jalousidør højre- eller venstrehængt. Handschuhspender, 2 Löcher für Handschuhe, 1 Loch für Mundschutz, 1 Rolladentür rechts oder links angeschlagen. Dispenser for gloves, 2 openings for gloves, 1 opening for face masks, 1 roll-front right or left.</p>	H 48 B 52,6 D/T 19
CV5701	 <p>Handskedispenser, 2 huller for handsker, 1 hul for mundbind, 1 jalousidør højre- eller venstrehængt. Handschuhspender, 2 Löcher für Handschuhe, 1 Loch für Mundschutz, 1 Rolladentür rechts oder links angeschlagen. Dispenser for gloves, 2 openings for gloves, 1 opening for face masks, 1 roll-front right or left.</p>	H 48 B 52,6 D/T 24
CV5750	<p>Jalousi i aluminiums-laminat, pr. skab. Rolladen im Aluminium Laminat, pro Schrank. Roll-front in aluminum laminate, per cabinet.</p>	H B D/T
CV5751	<p>Jalousi i andre farver. Rolladen im anderen Farben. Roll-front in other colors.</p>	H B D/T
CV5702	 <p>Handskedispenser, 2 huller for handsker, 1 hul for mundbind. Handschuhspender, 2 Löcher für Handschuhe, 1 Loch für Mundschutz. Dispenser for gloves, 2 openings for gloves, 1 opening for face masks.</p>	H 48 B 32,6 D/T 17

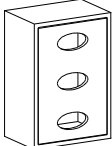
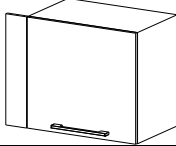
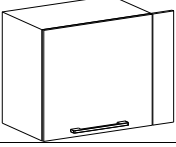
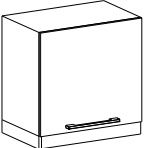
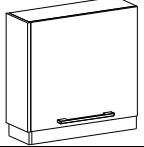
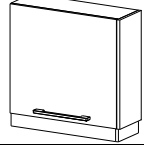
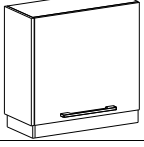
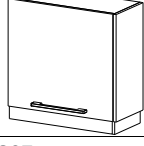
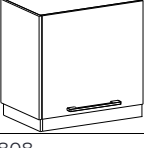
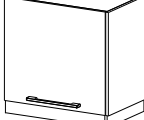

Klinikinventar

Praxismöbel

Varenr. Warennr. Article nr.	Beskrivelse / Beschreibung / Description	Mål i cm Mass Measure
CV5703	 <p>Handskedispenser, 2 huller for handsker, 1 hul for mundbind. Handschuhspender, 2 Löcher für Handschuhe, 1 Loch für Mundschutz. Dispenser for gloves, 2 openings for gloves, 1 opening for face masks.</p>	<p>H 48 B 32,6 D/T 22</p>
CV5800	 <p>Venstre tilpasningsstykke, incl. frontbeklædning. Linke Blende/Passtück mit Frontverkleidung. Left front adjusting panel incl. frontcovering.</p>	<p>H 48 B D/T</p>
CV5801	 <p>Højre tilpasningsstykke, incl. frontbeklædning. Rechte Blende/Passtück mit Frontverkleidung. Right front adjusting panel incl. frontcovering.</p>	<p>H 48 B D/T</p>
CV5802	 <p>Lysliste, pr. 10 cm. Lichtleiste, pro 10 cm. Light reflector for indirect lighting, per. 10 cm.</p>	<p>H 6 B D/T</p>
CV5803	 <p>Venstre sidebeklædning. Seitenverkleidung links. Left end panel.</p>	<p>H 48 B D/T 19</p>
CV5804	 <p>Højre sidebeklædning. Seitenverkleidung rechts. Right end panel.</p>	<p>H 48 B D/T 19</p>
CV5805	 <p>Venstre sidebeklædning. Seitenverkleidung links. Left end panel.</p>	<p>H 48 B D/T 24</p>
CV5806	 <p>Højre sidebeklædning. Seitenverkleidung rechts. Right end panel.</p>	<p>H 48 B D/T 24</p>
CV5807	 <p>Venstre sidebeklædning. Seitenverkleidung links. Left end panel.</p>	<p>H 48 B D/T 35</p>
CV5808	 <p>Højre sidebeklædning. Seitenverkleidung rechts. Right end panel.</p>	<p>H 48 B D/T 35</p>

Klinikinventar

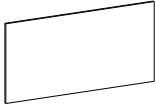
Praxismöbel

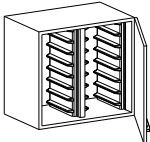
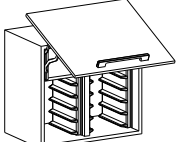
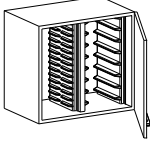
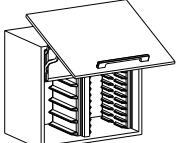
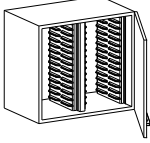
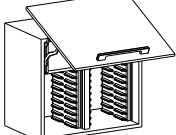
Varenr. Warennr. Article nr.	Beskrivelse / Beschreibung / Description	Mål i cm Mass Measure
CV5809	 <p>Vægbeklædning laminat, pr. 10 cm. Wandverkleidung Laminat, pro. 10 cm. Wall panel laminate, per. 10 cm.</p>	H 48 B D/T
CV5810	 <p>Laminathyld, pr. 10 cm. Laminatplatte, pro 10 cm. Shelf for wallmount, per 10 cm.</p>	H B D/T 33
CV5811	<p>Tillæg for laminater i højglansfarver, pr. 10 cm Aufschlag für Laminat in Hochglanzfarben, pro 10 cm. Additional price for glossy laminates, per 10 cm.</p>	H B D/T
CV5900	 <p>Indsats for 14 bakker m/låg Einsatz für 14 Normtrays mit Deckel. Plastic liner for 14 instrument trays with cover.</p>	H B 50 D/T
CV5901	 <p>Indsats for 10 bakker m/låg. Einsatz für 10 Normtrays mit Deckel. Plastic liner for 10 instrument trays with cover.</p>	H B 50 D/T
CV5902	 <p>Indsats for 14 bakker u/låg og 7 bakker m/ låg. Einsatz für 14 Normtrays ohne Deckel , 7 Normtrays mit Deckel. Plastic liner for 14 instrument trays with out cover and 7 instrument trays with cover.</p>	H B 50 D/T
CV5903	 <p>Indsats for 10 bakker u/låg og 5 bakker m/låg. Einsatz für 10 Trays ohne Deckel, 5 Trays mit Deckel. Plastic liner for 10 trays without cover, 5 trays with cover.</p>	H B 50 D/T
CV5904	 <p>Indsats for 28 bakker u/låg. Einsatz für 28 Normtrays ohne Deckel. Plastic liner for 28 instrument trays without cover.</p>	H B 50 D/T
CV5905	 <p>Indsats for 20 bakker u/låg. Einsatz für 20 Trays ohne Deckel. Plastic liner for 20 trays without cover.</p>	H B 50 D/T

Klinikinventar

Praxismöbel

Varenr. Warennr. Article nr.	Beskrivelse / Beschreibung / Description	Mål i cm Mass Measure
Mobilskabe	Fahrbarer Schränke	Mobile cabinets
CM8100	 <p>Mobilskab, 7 skuffer 8 cm. Softclose skinner. Fahrbarer Schrank, 7 Schubladen 8 cm. Softclose Schienen. Mobile cabinet, 7 drawers 8 cm. Softclose rails.</p>	<p>H 78 B 52,6 D/T 49</p>
CM8101	 <p>Mobilskab, 5 skuffer 8 cm, 1 skuffe 16 cm. Softclose skinner. Fahrbarer Schrank, 5 Schubladen 8 cm und 1 Schublade 16 cm. Softclose Schienen. Mobile cabinet, 5 drawers 8 cm, 1 drawer 16 cm. Softclose rails.</p>	<p>H 78 B 52,6 D/T 49</p>
CM8102	 <p>Mobilskab, 3 skuffer 8 cm, 2 skuffer 16 cm. Softclose skinner. Fahrbarer Schrank, 3 Schubladen 8 cm und 2 Schubladen 16 cm. Softclose Schienen. Mobile cabinet, 3 drawers 8 cm, 2 drawers 16 cm. Softclose rails.</p>	<p>H 78 B 52,6 D/T 49</p>
CM8103	 <p>Mobilskab m/forlænget bordplade, 5 skuffer 8 cm, 1 skuffe 16 cm. Softclose skinner. Fahrbarer Schrank mit verlängerte Arbeitsplatte, 5 Schubladen 8 cm und 1 Schublade 16 cm. Softclose Schienen. Mobile cabinet with winged worktop, 5 drawers 8 cm, 1 drawer 16 cm. Softclose rails.</p>	<p>H 78 B 52,6 D/T 49</p>
CM8200	 <p>Mobilskab, 7 skuffer 8 cm. Softclose skinner. Fahrbarer Schrank, 7 Schubladen 8 cm. Softclose Schienen. Mobile cabinet, 7 drawers 8 cm. Softclose rails.</p>	<p>H 86 B 52,6 D/T 49</p>
CM8201	 <p>Mobilskab, 5 skuffer 8 cm, 1 skuffe 16 cm. Softclose skinner. Fahrbarer Schrank, 5 Schubladen 8 cm und 1 Schublade 16 cm. Softclose Schienen. Mobile cabinet, 5 drawers 8 cm, 1 drawer 16 cm. Softclose rails.</p>	<p>H 86 B 52,6 D/T 49</p>
CM8202	 <p>Mobilskab, 3 skuffer 8 cm, 2 skuffer 16 cm. Softclose skinner. Fahrbarer Schrank, 3 Schubladen 8 cm und 2 Schubladen 16 cm. Softclose Schienen. Mobile cabinet, 3 drawers 8 cm, 2 drawers 16 cm. Softclose rails.</p>	<p>H 86 B 52,6 D/T 49</p>

danish healthcare design

Danish Healthcare
Design A/S
Drejøvej 8
9500 Hobro

+45 9851 1633
info@dhdas.dk
www.dhdas.dk
CVR nr. 64194615

climo