

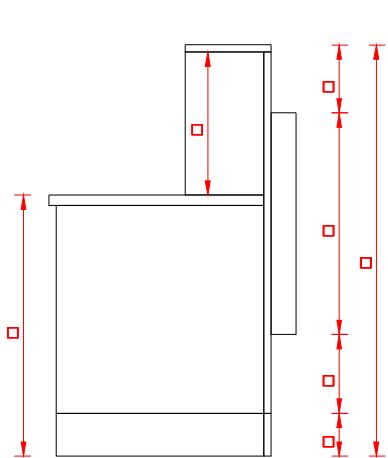



Målskitse  
 Maßzeichnung  
 Dimensional drawing



Model 2000

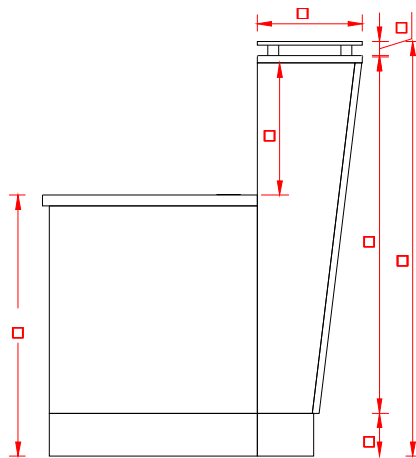

Model 5000

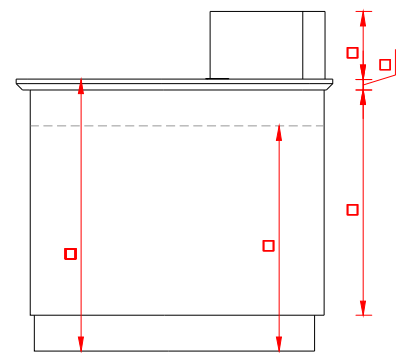

Model 6000



### Kontorindretning

### Büromöbel

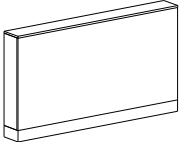
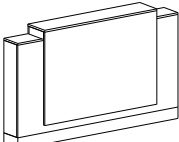
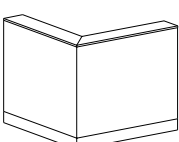
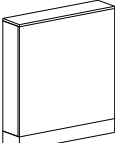
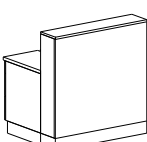
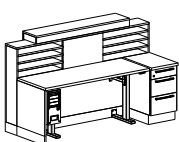

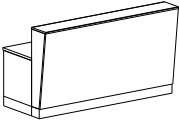
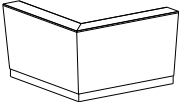
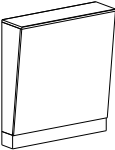
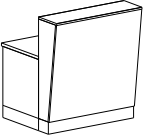
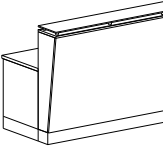
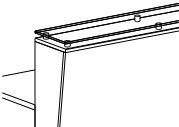

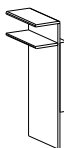
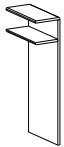

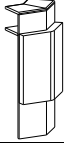
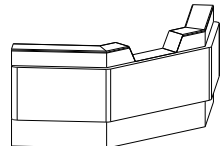
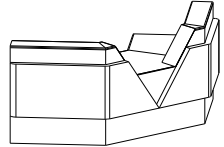
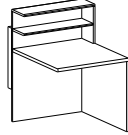
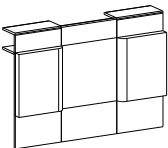
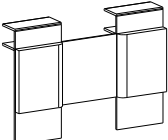
### Office Furniture

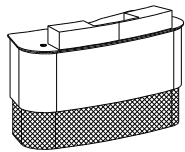
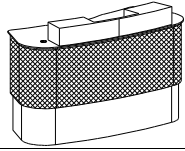
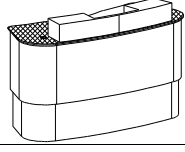
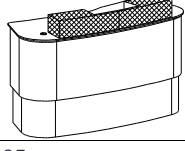
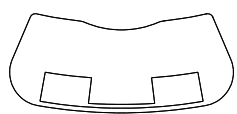
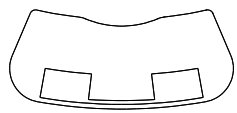

Varenr. Warennr. Article nr.	Beskrivelse / Beschreibung / Description	Mål i cm Mass Measure
<b>Model 7000</b>	<b>Modell 7000</b>	<b>Model 7000</b>
7001	 <p>Skrankebeklædning pr. 10 cm. Verkleidung für Empfangs-/Anmeldungstresen pro 10 cm. Counter covering per 10 cm.</p>	H B D/T
7002	 <p>Skrankebælte pr. 10 cm. Gürtel für Empfangs-/Anmeldungstresen pro 10 cm. Belt per 10 cm.</p>	H B D/T
7003	 <p>Hjørnesamling Eckverbindung Corner joint</p>	H B D/T
7004	 <p>Endegavl Giebel Endplate</p>	H B D/T
7005	 <p>Støttegavl Stützwange Support end</p>	H B D/T
7006	 <p>Posthylder i skranke, pr 10 cm Regalen, pro 10 cm Post shelves, per 10 cm.</p>	H B D/T

Varenr. Warennr. Article nr.	Beskrivelse / Beschreibung / Description	Mål i cm Mass Measure
<b>Model 5000</b>	<b>Modell 5000</b>	<b>Model 5000</b>
5001	 <p>Skrankebeklædning pr. 10 cm. Verkleidung für Empfangs-/Anmeldungstresen pro 10 cm. Counter covering per 10 cm.</p>	H 116 B D/T
5002	 <p>Hjørnesamling Eckverbindung Corner joint</p>	H B D/T
5003	 <p>Endegavl Giebel Endplate</p>	H B D/T
5004	 <p>Støttegavl Stützwange. Support end.</p>	H B D/T
5007	 <p>Topplade i 10 mm frostet glas. EFTER TILBUD. Arbeitsplatte aus 10 mm matt Glass. AUF NACHFRAGE. Worktop in 10 mm frosted glass. ACCORDING TO OFFER.</p>	H B D/T
5008	 <p>Rustfri cylindre til montering af glasplade. Edelstahl Zylinder für Glassmontage. Stainless steel cylinder for glass mounting.</p>	H B D/T

Varenr. Warennr. Article nr.	Beskrivelse / Beschreibung / Description	Mål i cm Mass Measure
<b>Model 2000</b>	<b>Modell 2000</b>	<b>Model 2000</b>
2001	 <p>Skrankebeklædning pr. 10 cm. Verkleidung für Empfangs-/Anmeldungstresen pro 10 cm. Counter covering per 10 cm.</p>	H 115 B D/T
2002	 <p>Skrankebeklædning uden bælte pr. 10 cm. Verkleidung für Empfangs-/Anmeldungstresen ohne Gürtel pro 10 cm. Counter covering without belt per 10 cm.</p>	H 115 B D/T
2003	 <p>Skrankebeklædning udført m/1/4 runding. Verkleidung für Empfangs-/Anmeldungstresen mit 1/4 rundung. Counter covering with 1/4 bending.</p>	H B D/T
2004	 <p>Afrundet bælte-hjørne. Abgerundete Gürtel-Ecken. Rounded belt-corner.</p>	H B D/T
2005	 <p>Kommunikationsåbning. Kommunikations Öffnung. Communications opening.</p>	H B D/T
2006	 <p>Kommunikationsåbning med V-udskæring. Kommunikations Öffnung mit V-Ausschnitt. Communications opening with V-cut.</p>	H B D/T
9007	 <p>Støttegavl. Stützwange. Support end.</p>	H B D/T
9009	 <p>Svingdør til Model 2000, fuld højde. Pendeltür für Model 2000, volle höhe. Swing door for Model 2000, full hieght.</p>	H B D/T
9010	 <p>Svingdør til Model 2000, højde som bælte. Pendeltür für Model 2000, höhe wie Gürtel. Swing door for Model 2000, height as belt.</p>	H B D/T

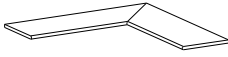

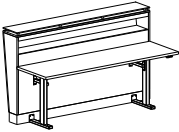
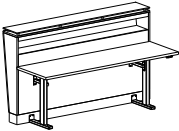
Varenr. Warennr. Article nr.	Beskrivelse / Beschreibung / Description	Mål i cm Mass Measure
<b>Model 6000</b>	<b>Modell 6000</b>	<b>Model 6000</b>
6001	 <p>Nederste front. Unteren Front. Bottom front.</p>	H 63 B D/T
6002	 <p>Øverste front. Oberen Front. Top front.</p>	H 63 B D/T
6003	 <p>Bordplade med laminat. Tischplatte mit Laminat. Tabletop with laminate.</p>	H B 200 D/T 89
6004	 <p>Overreol. Regal. Bookcase.</p>	H 19 B D/T
6005	 <p>Linoleum på bordplade. Linoleum auf Tischplatte. Linoleum on tabletop.</p>	H B D/T
6006	 <p>Læder på bordplade. Leder auf Tischplatte. Leather on tabletop.</p>	H B D/T

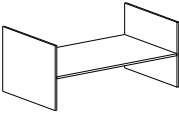
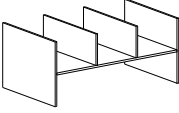
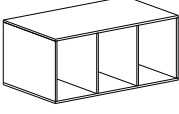
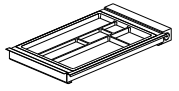
Varenr. Warennr. Article nr.	Beskrivelse / Beschreibung / Description	Mål i cm Mass Measure
<b>Bordplader</b>	<b>Arbeitsplatten</b>	<b>Worktops</b>
9001	Bordplade op til dybde 60 cm, pr. 10 cm.  Tischplatte bis Tiefe 60 cm, pr. 10 cm. Table top up to depth 60 cm, pr. 10 cm.	H B D/T 60
9002	Bordplade op til dybde 60-70 cm, pr. 10 cm.  Tischplatte bis Tiefe 60-70 cm, pr. 10 cm. Table top up to depth 60-70 cm, pr. 10 cm.	H B D/T 70
9003	Bordplade op til dybde 70-78 cm, pr. 10 cm.  Tischplatte bis Tiefe 70-78 cm, pr. 10 cm. Table top up to depth 70-78 cm, pr. 10 cm.	H B D/T 78
9004	Bordplade op til dybde 78-88 cm, pr. 10 cm.  Tischplatte bis Tiefe 78-88 cm, pr. 10 cm. Table top up to depth 78-88 cm, pr. 10 cm.	H B D/T 88
9005	Bordplade op til dybde 88-98 cm, pr. 10 cm.  Tischplatte bis Tiefe 88-98 cm, pr. 10 cm. Table top up to depth 88-98 cm, pr. 10 cm.	H B D/T 98
9006	Specialskæring af bordplade.  Spezialgeschnittene Tischplatte. Special cutting of countertop.	H B D/T
9008	Bordpladesamling  Tischplatte sammlung Countertop joint	H B D/T

Varenr. Warennr. Article nr.	Beskrivelse / Beschreibung / Description	Mål i cm Mass Measure
<b>Tilbehør skranke</b>	<b>Zubehör Empfang</b>	<b>Accessories for counters</b>
9015	 <p>Elektrisk bordstel højdejusterbar 70-120 cm. Farve : Alu Elektrisch Tischrahmen höhen verstellbar 70-120 cm. Farbe : Alu Electric table frame heightadjustable 70-120 cm. Colour : Alu</p>	H 70-120 B D/T
9016	 <p>Elektrisk bordstel højdejusterbar 70-120 cm. Farve : Sort Elektrisch Tischrahmen höhen verstellbar 70-120 cm. Farbe : Schwarz Electric table frame heightadjustable 70-120 cm. Colour : Black</p>	H 70-120 B D/T
9017	<p>Sikkerhedsskinne, pr. meter Sicherheitsschalter, pro meter Safety limit switch, pr. meter</p>	H B D/T
7007	 <p>LED striplight, max 3,5 meter pr. transformer. LED-Streifenlicht, max. 3,5 Meter pro. Transformator. LED strip light, max. 3,5 meter pr. transformer.</p>	H B D/T
7008	<p>Transformer til LED striplight. Incl. Netledning Transformator für LED-Lichtleiter. Incl. Netzkabel Transformer for LED striplight. Incl. Power cord</p>	H B D/T
7009	<p>Indbygget tænd/ sluk/ dæmpfunktion til striplight. Eingebaute Ein / Aus / Dämpfungsfunktion für Lichtband. Built-in on / off / damping function for strip light.</p>	H B D/T
10.01	 <p>Reolinddeler til skranke. Regaleinteiler. Shelf dividers.</p>	H 16,5 B 37,5 D/T 22,0
10.02	 <p>Reolinddeler til skranke. Regaleinteiler. Shelf dividers.</p>	H 16,5 B 37,5 D/T 22,0
10.03	 <p>Reolinddeler til skranke. Regaleinteiler. Shelf dividers.</p>	H 16,5 B 37,5 D/T 22,0
10.04	 <p>SlimTray Small alu m. lås. For montering under skrivebordsplade. SlimTray Small alu m. Schloss. Für Montage unter Schreibtisch-Platte. SlimTray Small alu w. lock. For mounting under desktop.</p>	H 40 B 413 D/T 260

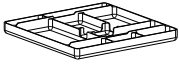
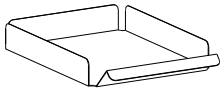
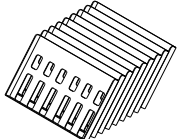
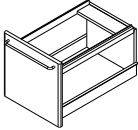
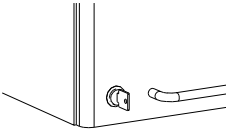

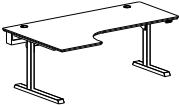
Varenr. Warennr. Article nr.	Beskrivelse / Beschreibung / Description	Mål i cm Mass Measure
10.05	 <p>Pennebakke. Einsatz für Schreibuntensilien. Pen tray.</p>	H B D/T
10.07	 <p>Blanketbakke A4. Schubfach für Formulare. Form tray A4.</p>	H B D/T
10.09	 <p>Skråfag til kabinet pr. stk. Max. 11 stk. pr. skuffe. Schrärfächer pro Stück. Inclined letter tray.</p>	H B D/T
10.10	 <p>Hængemappestativ til kabinet. Hängeordnerrahmen. Suspension file for cabinets.</p>	H B D/T
10.11	 <p>Lås til skab, pr. stk. Schränk, abschließbar, pro. Schloß. Lock mounted in door, per. Lock.</p>	H B D/T

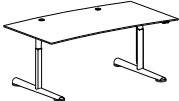
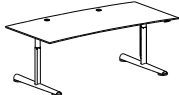
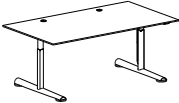
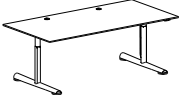
Varenr. Warennr. Article nr.	Beskrivelse / Beschreibung / Description	Mål i cm Mass Measure
<b>Elektriske skriveborde</b>	<b>Elektrische Schreibtische</b>	<b>Electric desks</b>
108	 <p>Skrivebord, elektrisk højdejusterbar stel 72-121 cm. Schreibtisch, Elektr.Höhenverstellbar 72-121 cm. Desk, electric heightadjustable 72-121 cm.</p>	<p><b>H</b> 72-121 <b>B</b> 180x120 <b>D/T</b> 80</p>
109	 <p>Skrivebord, elektrisk højdejusterbar stel 72-121 cm. Schreibtisch, Elektr.Höhenverstellbar 72-121 cm. Desk, electric heightadjustable 72-121 cm.</p>	<p><b>H</b> 72-121 <b>B</b> 200x120 <b>D/T</b> 80</p>
110	 <p>Skrivebord, elektrisk højdejusterbar stel 72-121 cm. Schreibtisch, Elektr.Höhenverstellbar 72-121 cm. Desk, electric heightadjustable 72-121 cm.</p>	<p><b>H</b> 72-121 <b>B</b> 180 <b>D/T</b> 120</p>
111	 <p>Skrivebord, elektrisk højdejusterbar stel 72-121 cm. Schreibtisch, Elektr.Höhenverstellbar 72-121 cm. Desk, electric heightadjustable 72-121 cm.</p>	<p><b>H</b> 72-121 <b>B</b> 180 <b>D/T</b> 120</p>
SK-112	 <p>Skrivebord, elektrisk højdejusterbar stel 72-121 cm. Schreibtisch, Elektr.Höhenverstellbar 72-121 cm. Desk, electric heightadjustable 72-121 cm.</p>	<p><b>H</b> 71/121 <b>B</b> 180 <b>D/T</b> 100</p>
SK-113	 <p>Skrivebord, elektrisk højdejusterbar stel 72-121 cm. Schreibtisch, Elektr.Höhenverstellbar 72-121 cm. Desk, electric heightadjustable 72-121 cm.</p>	<p><b>H</b> 71/121 <b>B</b> 200 <b>D/T</b> 100</p>
SK-114	 <p>Skrivebord, elektrisk højdejusterbar stel 72-121 cm. Schreibtisch, Elektr.Höhenverstellbar 72-121 cm. Desk, electric heightadjustable 72-121 cm.</p>	<p><b>H</b> 71/121 <b>B</b> 180 <b>D/T</b> 100</p>
SK-115	 <p>Skrivebord, elektrisk højdejusterbar stel 72-121 cm. Schreibtisch, Elektr.Höhenverstellbar 72-121 cm. Desk, electric heightadjustable 72-121 cm.</p>	<p><b>H</b> 71/121 <b>B</b> 200 <b>D/T</b> 100</p>

Varenr. Warennr. Article nr.	Beskrivelse / Beschreibung / Description	Mål i cm Mass Measure
------------------------------------	--	-----------------------------

Skriveborde	Schreibtische	Desks
-------------	---------------	-------

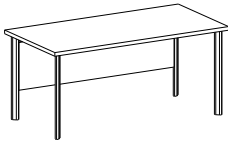
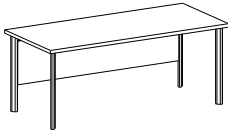
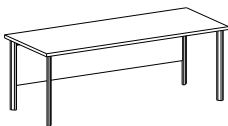
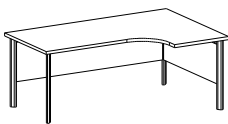
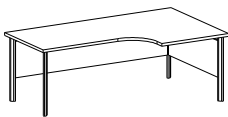
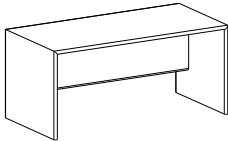
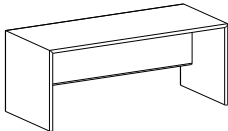
101	 <p>Skrivebord med fladovale ben, incl. frontplade og 2 stk. ledningsgennemføringer. Schreibtisch mit flachovalen Beinen, mit Frontplatte und 2 Kabeldurchführungen, Desk with flatoval legs, incl. front leaf and 2 pieces cable passages.</p>	<p>H 73 B 160 D/T 80</p>
102	 <p>Skrivebord med fladovale ben, incl. frontplade og 2 stk. ledningsgennemføringer. Schreibtisch mit flachovalen Beinen, mit Frontplatte und 2 Kabeldurchführungen Desk with flatoval legs, incl. front leaf and 2 pieces cable passages.</p>	<p>H 73 B 180 D/T 80</p>
103	 <p>Skrivebord med fladovale ben, incl. frontplade og 2 stk. ledningsgennemføringer. Schreibtisch mit flachovalen Beinen, mit Frontplatte und 2 Kabeldurchführungen Desk with flatoval legs, incl. front leaf and 2 pieces cable passages.</p>	<p>H 73 B 200 D/T 80</p>
104	 <p>Skrivebord med fladovale ben, incl. frontplade og 2 stk. ledningsgennemføringer. Schreibtisch mit flachovalen Beinen, mit Frontplatte und 2 Kabeldurchführungen Desk with flatoval legs, incl. front leaf and 2 pieces cable passages.</p>	<p>H 73 B 180x120 D/T 80</p>
105	 <p>Skrivebord med fladovale ben, incl. frontplade og 2 stk. ledningsgennemføringer. Schreibtisch mit flachovalen Beinen, mit Frontplatte und 2 Kabeldurchführungen Desk with flatoval legs, incl. front leaf and 2 pieces cable passages.</p>	<p>H 73 B 200x120 D/T 80</p>
106	 <p>Skrivebord med gavle i samme udførelse som bordplade og hjørnesamlinger i elox. alu eller naturtræ. Schreibtisch mit Giebel in die gleichen Ausführung wie die Tischplatte , Ecknaht im elox. Alu oder Echtholz. Desk with gables in the same style as the tabletop and corner joint in elox. alu. or natural wood.</p>	<p>H 73 B 160 D/T 80</p>
107	 <p>Skrivebord med gavle i samme udførelse som bordplade og hjørnesamlinger i elox. alu eller naturtræ. Schreibtisch mit Giebel in die gleichen Ausführung wie die Tischplatte , Ecknaht im elox. Alu oder Echtholz. Desk with gables in the same style as the tabletop and corner joint in elox. alu. or natural wood.</p>	<p>H 73 B 180 D/T 80</p>

Varenr. Warennr. Article nr.	Beskrivelse / Beschreibung / Description	Mål i cm Mass Measure
------------------------------------	--	-----------------------------

Sideborde	Nebentische	Side tables
-----------	-------------	-------------

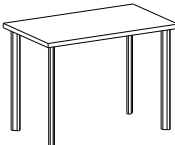
142	 <p>Sidebord til skrivebord med alu ben. Zustelltisch mit Alu-Beinen Side table with alu-legs.</p>	<p>H 73 B 100 D/T 60</p>
-----	---	----------------------------------

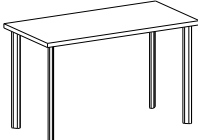
143	 <p>Sidebord til skrivebord med alu ben. Zustelltisch mit Alu-Beinen Side table with alu-legs.</p>	<p>H 73 B 120 D/T 60</p>
-----	---	----------------------------------

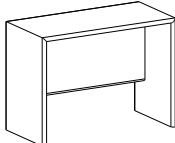
166	 <p>Sidebord med gavle i samme udførelse som topplade, hjørnesamlinger i elox. Aluminium. Zustelltisch mit Giebel in der gleichen Farbe wie die Tischplatte, Ecknaht im elox. Aluminium. Side table with gables in the same style as the tabletop and corner joint in elox. Aluminum.</p>	<p>H 73 B 100 D/T 50</p>
-----	--	----------------------------------

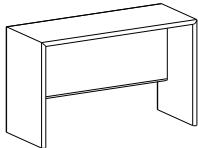
167	 <p>Sidebord med gavle i samme udførelse som topplade, hjørnesamlinger i elox. Aluminium. Zustelltisch mit Giebel in der gleichen Farbe wie die Tischplatte, Ecknaht im elox. Aluminium. Side table with gables in the same style as the tabletop and corner joint in elox. Aluminum.</p>	<p>H 73 B 120 D/T 50</p>
-----	---	----------------------------------



Kabinetter	Schubladensektion	Cabinets
------------	-------------------	----------

100D	 <p>Kabinet med 4 skuffer. Schubladenschrank mit 4 Schubladen. Cabinet with 4 drawers.</p>	<p>H 47 B 40 D/T 58</p>
------	---	---------------------------------

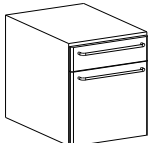
100E	 <p>Kabinet med 3 skuffer, plads til skråtag i nederste skuffe. Schubladenschrank m/3 Schubladen. Raum für Schrägfächer in den unteren Schublade. Cabinet w/3 drawers, space for inclined file trays in the bottom drawer.</p>	<p>H 47 B 40 D/T 58</p>
------	---	---------------------------------

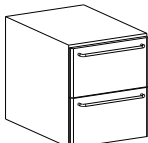
100F	 <p>Kabinet med 2 skuffer, plads til hængemapper i nederste skuffe. Schubladenschrank m/3 Schubladen. Raum für Hängerordner Rahmen in den unteren Schublade. Cabinet w/3 drawers, space for suspension file rack in the bottom drawer.</p>	<p>H 47 B 40 D/T 58</p>
------	---	---------------------------------

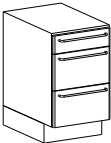
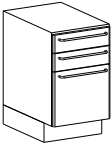
100G	 <p>Kabinet med 2 skuffer, plads til skråtag i begge skuffer. Schubladenschrank m/3 Schubladen. Raum für Schrägfächer in beiden Schubladen. Cabinet w/3 drawers, space for inclined file trays in both drawers.</p>	<p>H 47 B 40 D/T 58</p>
------	--	---------------------------------



Varenr. Warennr. Article nr.	Beskrivelse / Beschreibung / Description	Mål i cm Mass Measure
<b>Skuffekabinetter</b>	<b>Schubladensektion</b>	<b>Cabinet with drawers</b>
100HH	 <p>Mobil skuffeskab m/5 skuffer, 1 toplade med trækgreb. Fahrbarer Schrank m/5 Schubladen und 1 Abdeckplatte. Mobile cabinet w/5 drawers, cabinet top w/pull handle.</p>	<p>H 68,5 B 40 D/T 59,4</p>
100HS	 <p>Skuffeskab m/5 skuffer. Schubladenschrank m/5 Schubladen. Drawer cabinet w/5 drawers.</p>	<p>H 58 B 40 D/T 58</p>
100LH	 <p>Mobil skuffeskab m/3 skuffer, 1 toplade med trækgreb. Der er plads til skråfag i de 2 nederste skuffer. Fahrbarer Schrank m/3 Schubladen und 1 Abdeckplatte. Raum für Schrägfächer in den 2 unteren Schubladen. Mobile cabinet w/3 drawers, cabinet top w/pull handle. Space for inclined file trays in 2 drawers.</p>	<p>H 68,5 B 40 D/T 59,4</p>
100LS	 <p>Skuffeskab m/3 skuffer. Der er plads til skråfag i de 2 nederste skuffer. Schubladenschrank m/3 Schubladen. Raum für Schrägfächer in den 2 unteren Schubladen. Drawer cabinet w/3 drawers. Space for inclined file trays in 2 drawers.</p>	<p>H 58 B 40 D/T 58</p>
100JH	 <p>Mobil skuffeskab m/3 skuffer, 1 toplade med trækgreb. Der er plads til hængemapper i nederste skuffe. Fahrbarer Schrank m/3 Schubladen und 1 Abdeckplatte. Raum für Hängerordnerrahmen in den untere Schublade. Mobile cabinet w/3 drawers, cabinet top w/pull handle. Space for suspension file rack in the bottom drawer.</p>	<p>H 68,5 B 40 D/T 59,4</p>
100JS	 <p>Skuffeskab m/3 skuffer. Der er plads til hængemapper i nederste skuffe. Schubladenschrank m/3 Schubladen. Raum für Hängerordnerrahmen in den untere Schublade. Drawer cabinet w/3 drawers. Space for suspension file rack in the bottom drawer.</p>	<p>H 58 B 40 D/T 58</p>
100KH	 <p>Mobil skuffeskab m/2 skuffer og toplade med trækgreb. Der er plads til skråfag i øverste skuffe, og hængemapper i nederste skuffe. Fahrbarer Schrank m/2 Schubladen und 1 Abdeckplatte. Raum für Schrägfächer in 1. Schublade und Hängerordnerrahmen in den untere Schublade. Mobile cabinet w/2 drawers, cabinet top with pull handle. Space for inclined file trays in the top drawer and suspension file rack in the bottom drawer.</p>	<p>H 68,5 B 40 D/T 59,4</p>
100KS	 <p>Skuffeskab m/2 skuffer. Der er plads til skråfag i øverste skuffe og hængemapper i nederste skuffe. Schubladenschrank m/2 Schubladen. Raum für Schrägfächer in 1. Schublade und Hängerordnerrahmen in den untere Schublade. Drawer cabinet w/2 drawers. Space for inclined file trays in the top drawer and suspension file rack in the bottom drawer.</p>	<p>H 58 B 40 D/T 58</p>
100-2	<p>Centrallås i kabinet Zentralschloss im Schrank Central lock in cabinet</p>	<p>H B D/T</p>

Varenr. Warennr. Article nr.	Beskrivelse / Beschreibung / Description	Mål i cm Mass Measure
Skabe/reoler	Schränke/Regale	Cabinets/bookcases
171-33-30	 <p>Reol med stilbar hylde. Regalelement mit 1 verstellbaren Einlegeboden. Bookcase with 1 adjustable shelf.</p>	<p>H 74,1 B 30 D/T 33</p>
171-33-40	 <p>Reol med stilbar hylde. Regalelement mit 1 verstellbaren Einlegeboden. Bookcase with 1 adjustable shelf.</p>	<p>H 74,1 B 40 D/T 33</p>
171-33-50	 <p>Reol med stilbar hylde. Regalelement mit 1 verstellbaren Einlegeboden. Bookcase with 1 adjustable shelf.</p>	<p>H 74,1 B 50 D/T 33</p>
171-33-60	 <p>Reol med stilbar hylde. Regalelement mit 1 verstellbaren Einlegeboden. Bookcase with 1 adjustable shelf.</p>	<p>H 74,1 B 60 D/T 33</p>
171-33-80	 <p>Reol med stilbar hylde. Regalelement mit 1 verstellbaren Einlegeboden. Bookcase with 1 adjustable shelf.</p>	<p>H 74,1 B 80 D/T 33</p>
171-45-30	 <p>Reol med stilbar hylde. Regalelement mit 1 verstellbaren Einlegeboden. Bookcase with 1 adjustable shelf.</p>	<p>H 74,1 B 30 D/T 45</p>
171-45-40	 <p>Reol med stilbar hylde. Regalelement mit 1 verstellbaren Einlegeboden. Bookcase with 1 adjustable shelf.</p>	<p>H 74,1 B 40 D/T 45</p>
171-45-50	 <p>Reol med stilbar hylde. Regalelement mit 1 verstellbaren Einlegeboden. Bookcase with 1 adjustable shelf.</p>	<p>H 74,1 B 50 D/T 45</p>
171-45-60	 <p>Reol med stilbar hylde. Regalelement mit 1 verstellbaren Einlegeboden. Bookcase with 1 adjustable shelf.</p>	<p>H 74,1 B 60 D/T 45</p>
171-45-80	 <p>Reol med stilbar hylde. Regalelement mit 1 verstellbaren Einlegeboden. Bookcase with 1 adjustable shelf.</p>	<p>H 74,1 B 80 D/T 45</p>

Varenr. Warennr. Article nr.	Beskrivelse / Beschreibung / Description	Mål i cm Mass Measure
172-35-30	 <p>Vægskab m/1 dør, 1 hylde. Wandschrank m/1 Tür, 1 Einlegeboden. Wall cabinet w/1 door, 1 shelf.</p>	<p><b>H</b> 74,1 <b>B</b> 30 <b>D/T</b> 35</p>
172-35-40	 <p>Vægskab m/1 dør, 1 hylde. Wandschrank m/1 Tür, 1 Einlegeboden. Wall cabinet w/1 door, 1 shelf.</p>	<p><b>H</b> 74,1 <b>B</b> 40 <b>D/T</b> 35</p>
172-35-50	 <p>Vægskab m/1 dør, 1 hylde. Wandschrank m/1 Tür, 1 Einlegeboden. Wall cabinet w/1 door, 1 shelf.</p>	<p><b>H</b> 74,1 <b>B</b> 50 <b>D/T</b> 35</p>
172-35-60	 <p>Vægskab m/1 dør, 1 hylde. Wandschrank m/1 Tür, 1 Einlegeboden. Wall cabinet w/1 door, 1 shelf.</p>	<p><b>H</b> 74,1 <b>B</b> 60 <b>D/T</b> 35</p>
172-35-80	 <p>Vægskab m/2 døre, 1 hylde. Wandschrank m/2 Türen, 1 Einlegeboden. Wall cabinet w/2 doors, 1 shelf.</p>	<p><b>H</b> 74,1 <b>B</b> 80 <b>D/T</b> 35</p>
172-47-30	 <p>Vægskab m/1 dør, 1 hylde. Wandschrank m/1 Tür, 1 Einlegeboden. Wall cabinet w/1 door, 1 shelf.</p>	<p><b>H</b> 74,1 <b>B</b> 30 <b>D/T</b> 47</p>
172-47-40	 <p>Vægskab m/1 dør, 1 hylde. Wandschrank m/1 Tür, 1 Einlegeboden. Wall cabinet w/1 door, 1 shelf.</p>	<p><b>H</b> 74,1 <b>B</b> 40 <b>D/T</b> 47</p>
172-47-50	 <p>Vægskab m/1 dør, 1 hylde. Wandschrank m/1 Tür, 1 Einlegeboden. Wall cabinet w/1 door, 1 shelf.</p>	<p><b>H</b> 74,1 <b>B</b> 50 <b>D/T</b> 47</p>
172-47-60	 <p>Vægskab m/1 dør, 1 hylde. Wandschrank m/1 Tür, 1 Einlegeboden. Wall cabinet w/1 door, 1 shelf.</p>	<p><b>H</b> 74,1 <b>B</b> 60 <b>D/T</b> 47</p>
172-47-80	 <p>Vægskab m/2 døre , 1 hylde. Wandschrank m/2 Türen, 1 Einlegeboden. Wall cabinet w/2 doors, 1 shelf.</p>	<p><b>H</b> 75 <b>B</b> 80 <b>D/T</b> 47</p>

Varenr. Warennr. Article nr.	Beskrivelse / Beschreibung / Description	Mål i cm Mass Measure
173-47-40	 <p>Vægskab m/1 vitrinelåge, 1 hylde. Wandschrank m/1 Vitrinen Tür, 1 Einlegeboden. Wall cabinet w/1 glass door, 1 shelf.</p>	<p><b>H</b> 74,1 <b>B</b> 40 <b>D/T</b> 47</p>
173-47-50	 <p>Vægskab m/1 vitrinelåge, 1 hylde. Wandschrank m/1 Vitrinen Tür, 1 Einlegeboden. Wall cabinet w/1 glass door, 1 shelf.</p>	<p><b>H</b> 74,1 <b>B</b> 50 <b>D/T</b> 47</p>
173-47-60	 <p>Vægskab m/1 vitrinelåge, 1 hylde. Wandschrank m/1 Vitrinen Tür, 1 Einlegeboden. Wall cabinet w/1 glass door, 1 shelf.</p>	<p><b>H</b> 74,1 <b>B</b> 60 <b>D/T</b> 47</p>
173-47-80	 <p>Vægskab m/2 vitrinelåger, 1 hylde. Wandschrank m/2 Vitrinen Türen, 1 Einlegeboden. Wall cabinet w/2 glass doors, 1 shelf.</p>	<p><b>H</b> 74,1 <b>B</b> 80 <b>D/T</b> 47</p>
174-47-30	 <p>Underskab m/1 låge, 1 hylde. Unterschrank m/1 Tür, 1 Einlegeboden. Storage cabinet w/1 door, 1 shelf.</p>	<p><b>H</b> 74,1 <b>B</b> 30 <b>D/T</b> 47</p>
174-47-40	 <p>Underskab m/1 låge, 1 hylde. Unterschrank m/1 Tür, 1 Einlegeboden. Storage cabinet w/1 door, 1 shelf.</p>	<p><b>H</b> 74,1 <b>B</b> 40 <b>D/T</b> 47</p>
174-47-50	 <p>Underskab m/1 låge, 1 hylde. Unterschrank m/1 Tür, 1 Einlegeboden. Storage cabinet w/1 door, 1 shelf.</p>	<p><b>H</b> 74,1 <b>B</b> 50 <b>D/T</b> 47</p>
174-47-60	 <p>Underskab m/1 låge, 1 hylde. Unterschrank m/1 Tür, 1 Einlegeboden. Storage cabinet w/1 door, 1 shelf.</p>	<p><b>H</b> 74,1 <b>B</b> 60 <b>D/T</b> 47</p>
174-47-80	 <p>Underskab m/2 låger, 1 hylde. Unterschrank m/2 Türen, 1 Einlegeboden. Storage cabinet w/2 doors, 1 shelf.</p>	<p><b>H</b> 74,1 <b>B</b> 80 <b>D/T</b> 47</p>
174-58-30	 <p>Underskab m/1 låge, 1 hylde. Unterschrank m/1 Tür, 1 Einlegeboden. Storage cabinet w/1 door, 1 shelf.</p>	<p><b>H</b> 74,1 <b>B</b> 30 <b>D/T</b> 58</p>

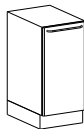
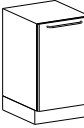
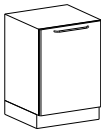
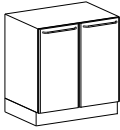
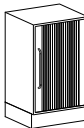
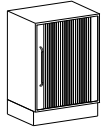
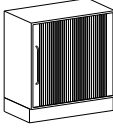

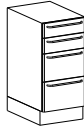
Varenr. Warennr. Article nr.	Beskrivelse / Beschreibung / Description	Mål i cm Mass Measure
174-58-40	 <p>Underskab m/1 låge, 1 hylde. Unterschrank m/1 Tür, 1 Einlegeboden. Storage cabinet w/1 door, 1 shelf.</p>	<p><b>H</b> 74,1 <b>B</b> 40 <b>D/T</b> 58</p>
174-58-50	 <p>Underskab m/1 låge, 1 hylde. Unterschrank m/1 Tür, 1 Einlegeboden. Storage cabinet w/1 door, 1 shelf.</p>	<p><b>H</b> 74,1 <b>B</b> 50 <b>D/T</b> 58</p>
174-58-60	 <p>Underskab m/1 låge, 1 hylde. Unterschrank m/1 Tür, 1 Einlegeboden. Storage cabinet w/1 door, 1 shelf.</p>	<p><b>H</b> 74,1 <b>B</b> 60 <b>D/T</b> 58</p>
174-58-80	 <p>Underskab m/2 låger, 1 hylde. Unterschrank m/2 Türen, 1 Einlegeboden. Storage cabinet w/2 doors, 1 shelf.</p>	<p><b>H</b> 74,1 <b>B</b> 80 <b>D/T</b> 58</p>
174-45J-50	 <p>Underskab med jalousilåge, 1 hylde. Unterschrank mit Rolladen Tür, 1 Einlegeboden. Lower cabinet with roll-front, 1 shelf.</p>	<p><b>H</b> 74,1 <b>B</b> 50 <b>D/T</b> 45</p>
174-45J-60	 <p>Underskab med jalousilåge, 1 hylde. Unterschrank mit Rolladen Tür, 1 Einlegeboden. Lower cabinet with roll- front, 1 shelf.</p>	<p><b>H</b> 74,1 <b>B</b> 60 <b>D/T</b> 45</p>
174-45J-80	 <p>Underskab med jalousilåge, 1 hylde. Unterschrank mit Rolladen Tür, 1 Einlegeboden. Lower cabinet with roll- front, 1 shelf.</p>	<p><b>H</b> 74,1 <b>B</b> 80 <b>D/T</b> 45</p>
175-47-40	 <p>Skuffeskab m/4 skuffer. Der er plads til skråfag i de 2 nederste skuffer. Schubladen Schrank m/4 Schubladen. Raum für Schrägfächer in den 2 unteren Schubladen. Drawer cabinet w/4 drawers. Space for inclined file trays in the 2 bottom drawers.</p>	<p><b>H</b> 74,1 <b>B</b> 40 <b>D/T</b> 47</p>
175-47-50	 <p>Skuffeskab m/4 skuffer. Schubladen Schrank m/4 Schubladen. Drawer cabinet w/4 drawers.</p>	<p><b>H</b> 74,1 <b>B</b> 50 <b>D/T</b> 47</p>
175-58-40	 <p>Skuffeskab m/4 skuffer. Der er plads til skråfag i de 2 nederste skuffer. Schubladen Schrank m/4 Schubladen. Raum für Schrägfächer in den 2 unteren Schubladen. Drawer cabinet w/4 drawers. Space for inclined file trays in the 2 bottom drawers.</p>	<p><b>H</b> 74,1 <b>B</b> 40 <b>D/T</b> 58</p>

Varenr. Warennr. Article nr.	Beskrivelse / Beschreibung / Description	Mål i cm Mass Measure
------------------------------------	--	-----------------------------

175-58-50



Skuffeskab m/4 skuffer.

Schubladen Schrank m/4 Schubladen.

Drawer cabinet w/4 drawers.

H 74,1

B 50

D/T 58

Indretning

Einrichtung

Arrangements

2

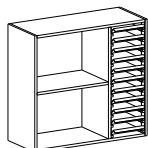

11 A4 blanketbakker indbygget i reol.

11 DIN A4 Schubfächer in Schrank eingebaut.

11 A4 form trays built in to cabinet.

H 74,1

B

D/T

Varenr. Warennr. Article nr.	Beskrivelse / Beschreibung / Description	Mål i cm Mass Measure
<b>Diverse tilbehør</b>	<b>Verschiedene Zubehör</b>	<b>Additional Accessories</b>
10.19H	Kabelgennemføring Ø 80 mm.Hvid Kabeldurchlass Ø 80 mm.Weiss Cable passage. Ø 80 mm. White.	H B D/T
10.19S	Kabelgennemføring Ø 80 mm.Sort Kabeldurchlass Ø 80 mm.Schwarz Cable passage. Ø 80 mm. Black.	H B D/T
10.19B	Kabelgennemføring Ø 80 mm. Børstet stål. Kabeldurchlass Ø 80 mm. Edelstahl. Cable passage Ø 80 mm. Stainless steel.	H B D/T
10.19-1H	Kabelgennemføring Ø 60 mm.Hvid Kabeldurchlass Ø 60 mm.Weiss Cable passage. Ø 60 mm. White.	H B D/T
10.19-1S	Kabelgennemføring Ø 60 mm.Sort Kabeldurchlass Ø 60 mm.Schwarz Cable passage. Ø 60 mm. Black.	H B D/T
10.19-1B	Kabelgennemføring Ø 60 mm. Børstet stål. Kabeldurchlass Ø 60 mm. Edelstahl. Cable passage Ø 60 mm. Stainless steel.	H B D/T
9020	Alu ben, fladovale 70-85 cm. Alu-beine, flachoval, 70-85 cm. Alu-legs, flatoval, 70-85 cm.	H 78 B D/T
9021	Stålben, krom. Stahlbein, chrom. Steel leg, chrome.	H 76 B D/T
9022	Tilpasningsstykke til underskabe Blende für Unterschränke Adjusting panel for cabinets	H 74,1 B D/T
9023	Tilpasningsstykke til overskabe Blende für Wandschränke Adjusting panel for wall cabinets	H 74,1 B D/T

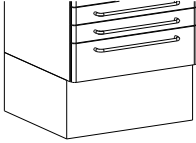
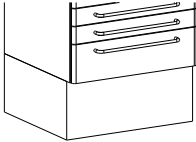
Varenr. Warennr. Article nr.	Beskrivelse / Beschreibung / Description	Mål i cm Mass Measure
2012	 <p>Alu sokkel pr. m. Alu Sockel, pro. m. Alu plinth per. m.</p>	<p>H 12 B D/T</p>
2013	 <p>Laminatsokkel, pr. meter Laminat-sockel, pro meter Lamainate plinth, per. Meter</p>	<p>H 12 B D/T</p>

# danish healthcare design

Danish Healthcare  
Design A/S  
Drejøvej 8  
9500 Hobro

+45 9851 1633  
info@dhdas.dk  
www.dhdas.dk  
CVR nr. 64194615

climo