

danish healthcare design

Typeliste / Typeliste / Typelist 2022

Climo Office

Målskitse
Maßzeichnung
Dimensional drawing

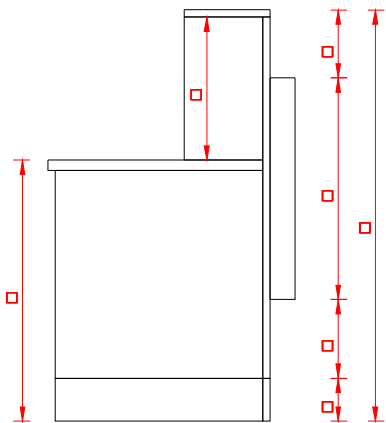

Model 2000

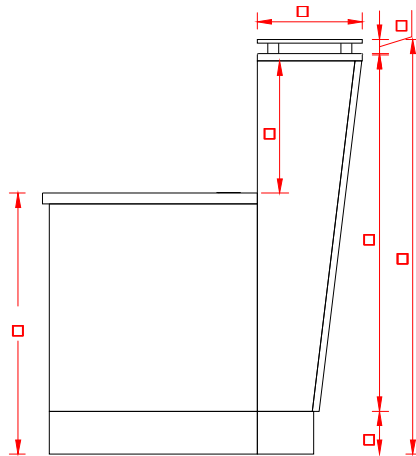

Model 5000

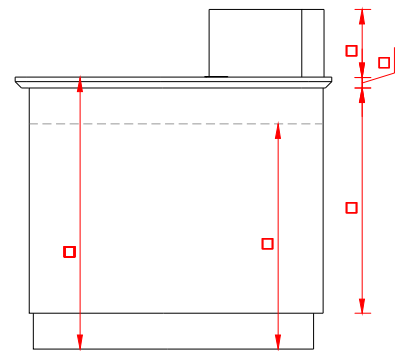



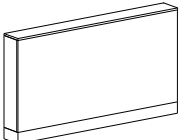
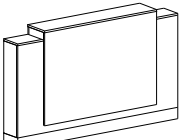
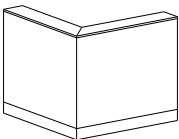
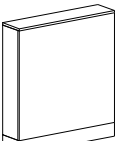
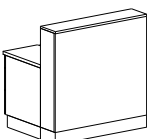
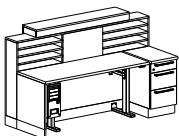

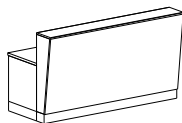
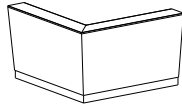
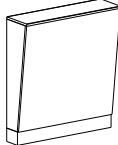
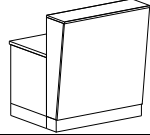
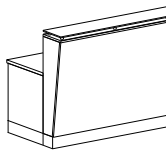
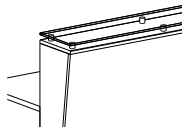

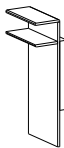
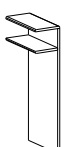
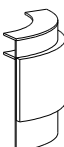
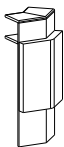
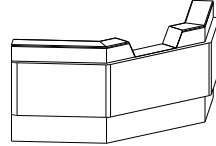
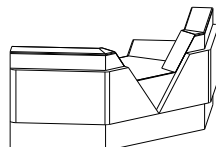
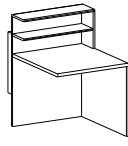
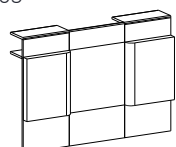
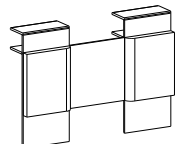
Model 6000

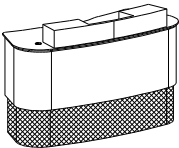
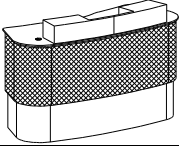
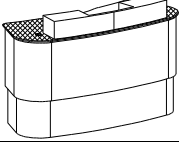
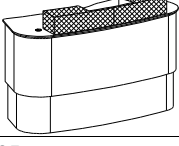
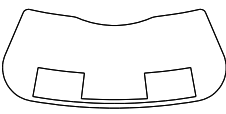
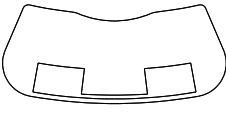

Varenr. Warennr. Article nr.	Beskrivelse / Beschreibung / Description	Mål i cm Mass Measure
Model 7000	Modell 7000	Model 7000
7001	 <p>Skrankebeklædning pr. 10 cm. Verkleidung für Empfangs-/Anmeldungstresen pro 10 cm. Counter covering per 10 cm.</p>	H B D/T
7002	 <p>Skrankebælte pr. 10 cm. Gürtel für Empfangs-/Anmeldungstresen pro 10 cm. Belt per 10 cm.</p>	H B D/T
7003	 <p>Hjørnesamling Eckverbindung Corner joint</p>	H B D/T
7004	 <p>Endegavl Giebel Endplate</p>	H B D/T
7005	 <p>Støttegavl Stützwange Support end</p>	H B D/T
7006	 <p>Posthylder i skranke, pr 10 cm Regalen, pro 10 cm Post shelves, per 10 cm.</p>	H B D/T

Varenr. Warennr. Article nr.	Beskrivelse / Beschreibung / Description	Mål i cm Mass Measure
Model 5000	Modell 5000	Model 5000
5001	 <p>Skrankebeklædning pr. 10 cm. Verkleidung für Empfangs-/Anmeldungstresen pro 10 cm. Counter covering per 10 cm.</p>	H 116 B D/T
5002	 <p>Hjørnesamling Eckverbindung Corner joint</p>	H B D/T
5003	 <p>Endegavl Giebel Endplate</p>	H B D/T
5004	 <p>Støttegavl Stützwange. Support end.</p>	H B D/T
5007	 <p>Topplade i 10 mm frostet glas. EFTER TILBUD. Arbeitsplatte aus 10 mm matt Glass. AUF NACHFRAGE. Worktop in 10 mm frosted glass. ACCORDING TO OFFER.</p>	H B D/T
5008	 <p>Rustfri cylindre til montering af glasplade. Edelstahl Zylinder für Glassmontage. Stainless steel cylinder for glass mounting.</p>	H B D/T

Varenr. Warennr. Article nr.	Beskrivelse / Beschreibung / Description	Mål i cm Mass Measure
Model 2000	Modell 2000	Model 2000
2001	 <p>Skrankebeklædning pr. 10 cm. Verkleidung für Empfangs-/Anmeldungstresen pro 10 cm. Counter covering per 10 cm.</p>	H 115 B D/T
2002	 <p>Skrankebeklædning uden bælte pr. 10 cm. Verkleidung für Empfangs-/Anmeldungstresen ohne Gürtel pro 10 cm. Counter covering without belt per 10 cm.</p>	H 115 B D/T
2003	 <p>Skrankebeklædning udført m/1/4 runding. Verkleidung für Empfangs-/Anmeldungstresen mit 1/4 rundung. Counter covering with 1/4 bending.</p>	H B D/T
2004	 <p>Afrundet bælte-hjørne. Abgerundete Gürtel-Ecken. Rounded belt-corner.</p>	H B D/T
2005	 <p>Kommunikationsåbning. Kommunikations Öffnung. Communications opening.</p>	H B D/T
2006	 <p>Kommunikationsåbning med V-udskæring. Kommunikations Öffnung mit V-Ausschnitt. Communications opening with V-cut.</p>	H B D/T
9007	 <p>Støttegavl. Stützwange. Support end.</p>	H B D/T
9009	 <p>Svingdør til Model 2000, fuld højde. Pendeltür für Model 2000, volle höhe. Swing door for Model 2000, full hieght.</p>	H B D/T
9010	 <p>Svingdør til Model 2000, højde som bælte. Pendeltür für Model 2000, höhe wie Gürtel. Swing door for Model 2000, height as belt.</p>	H B D/T

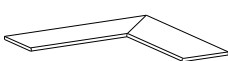
Varenr. Warennr. Article nr.	Beskrivelse / Beschreibung / Description	Mål i cm Mass Measure
Model 6000	Modell 6000	Model 6000
6001	 <p>Nederste front. Unteren Front. Bottom front.</p>	H 63 B D/T
6002	 <p>Øverste front. Oberen Front. Top front.</p>	H 63 B D/T
6003	 <p>Bordplade med laminat. Tischplatte mit Laminat. Tabletop with laminate.</p>	H B 200 D/T 89
6004	 <p>Overreol. Regal. Bookcase.</p>	H 19 B D/T
6005	 <p>Linoleum på bordplade. Linoleum auf Tischplatte. Linoleum on tabletop.</p>	H B D/T
6006	 <p>Læder på bordplade. Leder auf Tischplatte. Leather on tabletop.</p>	H B D/T

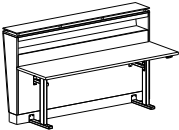
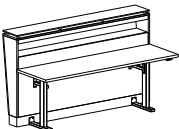

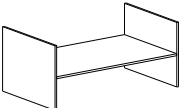
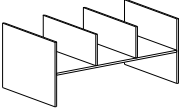
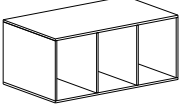
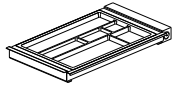
Varenr. Warennr. Article nr.	Beskrivelse / Beschreibung / Description	Mål i cm Mass Measure
Bordplader	Arbeitsplatten	Worktops
9001	Bordplade op til dybde 60 cm, pr. 10 cm.  Tischplatte bis Tiefe 60 cm, pr. 10 cm. Table top up to depth 60 cm, pr. 10 cm.	H B D/T 60
9002	Bordplade op til dybde 60-70 cm, pr. 10 cm.  Tischplatte bis Tiefe 60-70 cm, pr. 10 cm. Table top up to depth 60-70 cm, pr. 10 cm.	H B D/T 70
9003	Bordplade op til dybde 70-78 cm, pr. 10 cm.  Tischplatte bis Tiefe 70-78 cm, pr. 10 cm. Table top up to depth 70-78 cm, pr. 10 cm.	H B D/T 78
9004	Bordplade op til dybde 78-88 cm, pr. 10 cm.  Tischplatte bis Tiefe 78-88 cm, pr. 10 cm. Table top up to depth 78-88 cm, pr. 10 cm.	H B D/T 88
9005	Bordplade op til dybde 88-98 cm, pr. 10 cm.  Tischplatte bis Tiefe 88-98 cm, pr. 10 cm. Table top up to depth 88-98 cm, pr. 10 cm.	H B D/T 98
9006	Specialskæring af bordplade.  Spezialgeschnittene Tischplatte. Special cutting of countertop.	H B D/T
9008	Bordpladesamling  Tischplatte sammlung Countertop joint	H B D/T

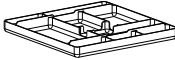
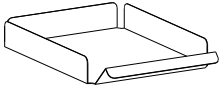
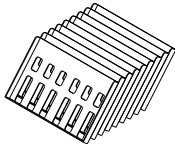
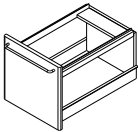
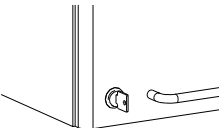
Varenr. Warennr. Article nr.	Beskrivelse / Beschreibung / Description	Mål i cm Mass Measure
Tilbehør skranke	Zubehör Empfang	Accessories for counters
9015	 <p>Elektrisk bordstel højdejusterbar 70-120 cm. Farve : Alu Elektrisch Tischrahmen höhen verstellbar 70-120 cm. Farbe : Alu Electric table frame heightadjustable 70-120 cm. Colour : Alu</p>	H 70-120 B D/T
9016	 <p>Elektrisk bordstel højdejusterbar 70-120 cm. Farve : Sort Elektrisch Tischrahmen höhen verstellbar 70-120 cm. Farbe : Schwarz Electric table frame heightadjustable 70-120 cm. Colour : Black</p>	H 70-120 B D/T
9017	<p>Sikkerhedsskinne, pr. meter Sicherheitsschalter, pro meter Safety limit switch, pr. meter</p>	H B D/T
7007	 <p>LED striplight, max 3,5 meter pr. transformer. LED-Streifenlicht, max. 3,5 Meter pro. Transformator. LED strip light, max. 3,5 meter pr. transformer.</p>	H B D/T
7008	<p>Transformer til LED striplight. Incl. Netledning Transformator für LED-Lichtleiter. Incl. Netzkabel Transformer for LED striplight. Incl. Power cord</p>	H B D/T
7009	<p>Indbygget tænd/sluk/dæmperfunktion til striplight. Eingebaute Ein / Aus / Dämpfungsfunktion für Lichtband. Built-in on / off / damping function for strip light.</p>	H B D/T
10.01	 <p>Reolinddeler til skranke. Regaleinteiler. Shelf dividers.</p>	H 16,5 B 37,5 D/T 22,0
10.02	 <p>Reolinddeler til skranke. Regaleinteiler. Shelf dividers.</p>	H 16,5 B 37,5 D/T 22,0
10.03	 <p>Reolinddeler til skranke. Regaleinteiler. Shelf dividers.</p>	H 16,5 B 37,5 D/T 22,0
10.04	 <p>SlimTray Small alu m. lås. For montering under skrivebordsplade. SlimTray Small alu m. Schloss. Für Montage unter Schreibtisch-Platte. SlimTray Small alu w. lock. For mounting under desktop.</p>	H 40 B 413 D/T 260

Varenr. Warennr. Article nr.	Beskrivelse / Beschreibung / Description	Mål i cm Mass Measure
10.05	 <p>Pennebakke. Einsatz für Schreibuntensilien. Pen tray.</p>	H B D/T
10.07	 <p>Blanketbakke A4. Schubfach für Formulare. Form tray A4.</p>	H B D/T
10.09	 <p>Skråfag til kabinet pr. stk. Max. 11 stk. pr. skuffe. Schrärfächer pro Stück. Inclined letter tray.</p>	H B D/T
10.10	 <p>Hængemappestativ til kabinet. Hängeordnerrahmen. Suspension file for cabinets.</p>	H B D/T
10.11	 <p>Lås til skab, pr. stk. Schränk, abschließbar, pro. Schloß. Lock mounted in door, per. Lock.</p>	H B D/T

Varenr. Warennr. Article nr.	Beskrivelse / Beschreibung / Description	Mål i cm Mass Measure
------------------------------------	--	-----------------------------

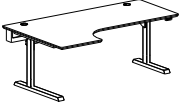
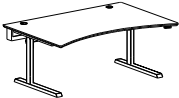
Elektriske skriveborde	Elektrische Schreibtische	Electric desks
------------------------	---------------------------	----------------

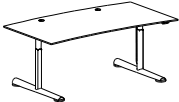
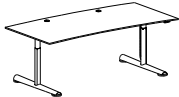
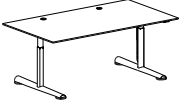
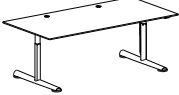
108	 <p>Skrivebord, elektrisk højdejusterbar stel 72-121 cm. Schreibtisch, Elektr.Höhenverstellbar 72-121 cm. Desk, electric heightadjustable 72-121 cm.</p>	<p>H 72-121 B 180x120 D/T 80</p>
109	 <p>Skrivebord, elektrisk højdejusterbar stel 72-121 cm. Schreibtisch, Elektr.Höhenverstellbar 72-121 cm. Desk, electric heightadjustable 72-121 cm.</p>	<p>H 72-121 B 200x120 D/T 80</p>
110	 <p>Skrivebord, elektrisk højdejusterbar stel 72-121 cm. Schreibtisch, Elektr.Höhenverstellbar 72-121 cm. Desk, electric heightadjustable 72-121 cm.</p>	<p>H 72-121 B 180 D/T 120</p>
111	 <p>Skrivebord, elektrisk højdejusterbar stel 72-121 cm. Schreibtisch, Elektr.Höhenverstellbar 72-121 cm. Desk, electric heightadjustable 72-121 cm.</p>	<p>H 72-121 B 180 D/T 120</p>
SK-112	 <p>Skrivebord, elektrisk højdejusterbar stel 72-121 cm. Schreibtisch, Elektr.Höhenverstellbar 72-121 cm. Desk, electric heightadjustable 72-121 cm.</p>	<p>H 71/121 B 180 D/T 100</p>
SK-113	 <p>Skrivebord, elektrisk højdejusterbar stel 72-121 cm. Schreibtisch, Elektr.Höhenverstellbar 72-121 cm. Desk, electric heightadjustable 72-121 cm.</p>	<p>H 71/121 B 200 D/T 100</p>
SK-114	 <p>Skrivebord, elektrisk højdejusterbar stel 72-121 cm. Schreibtisch, Elektr.Höhenverstellbar 72-121 cm. Desk, electric heightadjustable 72-121 cm.</p>	<p>H 71/121 B 180 D/T 100</p>
SK-115	 <p>Skrivebord, elektrisk højdejusterbar stel 72-121 cm. Schreibtisch, Elektr.Höhenverstellbar 72-121 cm. Desk, electric heightadjustable 72-121 cm.</p>	<p>H 71/121 B 200 D/T 100</p>

Varenr. Warennr. Article nr.	Beskrivelse / Beschreibung / Description	Mål i cm Mass Measure
------------------------------------	--	-----------------------------

Skriveborde	Schreibtische	Desks
-------------	---------------	-------

101	 <p>Skrivebord med fladovale ben, incl. frontplade og 2 stk. ledningsgennemføringer. Schreibtisch mit flachovalen Beinen, mit Frontplatte und 2 Kabeldurchführungen. Desk with flatoval legs, incl. front leaf and 2 pieces cable passages.</p>	<p>H 73 B 160 D/T 80</p>
102	 <p>Skrivebord med fladovale ben, incl. frontplade og 2 stk. ledningsgennemføringer. Schreibtisch mit flachovalen Beinen, mit Frontplatte und 2 Kabeldurchführungen. Desk with flatoval legs, incl. front leaf and 2 pieces cable passages.</p>	<p>H 73 B 180 D/T 80</p>
103	 <p>Skrivebord med fladovale ben, incl. frontplade og 2 stk. ledningsgennemføringer. Schreibtisch mit flachovalen Beinen, mit Frontplatte und 2 Kabeldurchführungen. Desk with flatoval legs, incl. front leaf and 2 pieces cable passages.</p>	<p>H 73 B 200 D/T 80</p>
104	 <p>Skrivebord med fladovale ben, incl. frontplade og 2 stk. ledningsgennemføringer. Schreibtisch mit flachovalen Beinen, mit Frontplatte und 2 Kabeldurchführungen. Desk with flatoval legs, incl. front leaf and 2 pieces cable passages.</p>	<p>H 73 B 180x120 D/T 80</p>
105	 <p>Skrivebord med fladovale ben, incl. frontplade og 2 stk. ledningsgennemføringer. Schreibtisch mit flachovalen Beinen, mit Frontplatte und 2 Kabeldurchführungen. Desk with flatoval legs, incl. front leaf and 2 pieces cable passages.</p>	<p>H 73 B 200x120 D/T 80</p>
106	 <p>Skrivebord med gavle i samme udførelse som bordplade og hjørnesamlinger i elox. alu eller naturtræ. Schreibtisch mit Giebel in die gleichen Ausführung wie die Tischplatte, Ecknaht im elox. Alu oder Echtholz. Desk with gables in the same style as the tabletop and corner joint in elox. alu. or natural wood.</p>	<p>H 73 B 160 D/T 80</p>
107	 <p>Skrivebord med gavle i samme udførelse som bordplade og hjørnesamlinger i elox. alu eller naturtræ. Schreibtisch mit Giebel in die gleichen Ausführung wie die Tischplatte, Ecknaht im elox. Alu oder Echtholz. Desk with gables in the same style as the tabletop and corner joint in elox. alu. or natural wood.</p>	<p>H 73 B 180 D/T 80</p>

Varenr. Warennr. Article nr.	Beskrivelse / Beschreibung / Description	Mål i cm Mass Measure
------------------------------------	--	-----------------------------

Sideborde	Nebentische	Side tables
-----------	-------------	-------------

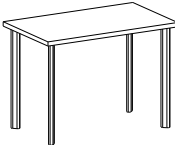
142	 <p>Sidebord til skrivebord med alu ben. Zustelltisch mit Alu-Beinen Side table with alu-legs.</p>	<p>H 73 B 100 D/T 60</p>
-----	---	----------------------------------

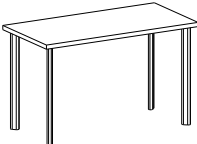
143	 <p>Sidebord til skrivebord med alu ben. Zustelltisch mit Alu-Beinen Side table with alu-legs.</p>	<p>H 73 B 120 D/T 60</p>
-----	---	----------------------------------

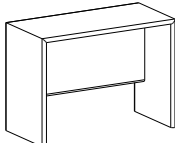
166	 <p>Sidebord med gavle i samme udførelse som topplade, hjørnesamlinger i elox. Aluminium. Zustelltisch mit Giebel in der gleichen Farbe wie die Tischplatte, Ecknaht im elox. Aluminium. Side table with gables in the same style as the tabletop and corner joint in elox. Aluminum.</p>	<p>H 73 B 100 D/T 50</p>
-----	--	----------------------------------

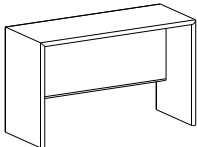

167	 <p>Sidebord med gavle i samme udførelse som topplade, hjørnesamlinger i elox. Aluminium. Zustelltisch mit Giebel in der gleichen Farbe wie die Tischplatte, Ecknaht im elox. Aluminium. Side table with gables in the same style as the tabletop and corner joint in elox. Aluminum.</p>	<p>H 73 B 120 D/T 50</p>
-----	---	----------------------------------

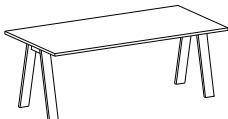



Konferenceborde	Konferenztische	Conference tables
-----------------	-----------------	-------------------

120	 <p>Konferencebord med A-shape benstel i RAL 9005 sort eller lakeret stål. 2000x1000 mm. Konferenztisch mit A-shape Beine in RAL 9005 schwarz oder Stahl Lakiert. 2000x1000 mm. Conferencetable with A-shape legs in RAL 9005 black or lacquered steel. 2000x1000 mm.</p>	<p>H 750 B 1000 D/T 2000</p>
-----	--	--------------------------------------

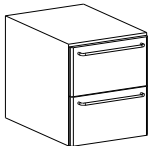
121	 <p>Konferencebord med A-shape benstel i RAL 9005 sort eller lakeret stål. 2600x1000 mm. Konferenztisch mit A-shape Beine in RAL 9005 schwarz oder Stahl Lakiert. 2600x1000 mm. Conferencetable with A-shape legs in RAL 9005 black or lacquered steel. 2600x1000 mm.</p>	<p>H 750 B 1000 D/T 2600</p>
-----	--	--------------------------------------

122	 <p>Konferencebord med A-shape benstel i RAL 9005 sort eller lakeret stål. 3200x1000 mm. Konferenztisch mit A-shape Beine in RAL 9005 schwarz oder Stahl Lakiert. 3200x1000 mm. Conferencetable with A-shape legs in RAL 9005 black or lacquered steel. 3600x1000 mm.</p>	<p>H 750 B 1000 D/T 3200</p>
-----	--	--------------------------------------

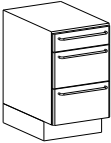
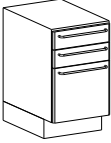
Varenr. Warennr. Article nr.	Beskrivelse / Beschreibung / Description	Mål i cm Mass Measure
Kabinetter	Schubladensektion	Cabinets
100D	 <p>Kabinet med 4 skuffer. Schubladenschrank mit 4 Schubladen. Cabinet with 4 drawers.</p>	<p>H 47 B 40 D/T 58</p>
100E	 <p>Kabinet med 3 skuffer, plads til skråfag i nederste skuffe. Schubladenschrank m/3 Schubladen. Raum für Schrägfächer in den unteren Schublade. Cabinet w/3 drawers, space for inclined file trays in the bottom drawer.</p>	<p>H 47 B 40 D/T 58</p>
100F	 <p>Kabinet med 2 skuffer, plads til hængemapper i nederste skuffe. Schubladenschrank m/3 Schubladen. Raum für Hängerordner Rahmen in den unteren Schublade. Cabinet w/3 drawers, space for suspension file rack in the bottom drawer.</p>	<p>H 47 B 40 D/T 58</p>
100G	 <p>Kabinet med 2 skuffer, plads til skråfag i begge skuffer. Schubladenschrank m/3 Schubladen. Raum für Schrägfächer in beiden Schubladen. Cabinet w/3 drawers, space for inclined file trays in both drawers.</p>	<p>H 47 B 40 D/T 58</p>

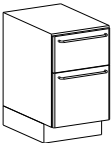
Varenr. Warennr. Article nr.	Beskrivelse / Beschreibung / Description	Mål i cm Mass Measure
Skuffekabinetter	Schubladensektion	Cabinet with drawers
100HH	 <p>Mobil skuffeskab m/5 skuffer, 1 toplade med trækgreb. Fahrbarer Schrank m/5 Schubladen und 1 Abdeckplatte. Mobile cabinet w/5 drawers, cabinet top w/pull handle.</p>	<p>H 68,5 B 40 D/T 59,4</p>
100HS	 <p>Skuffeskab m/5 skuffer. Schubladenschrank m/5 Schubladen. Drawer cabinet w/5 drawers.</p>	<p>H 58 B 40 D/T 58</p>
100LH	 <p>Mobil skuffeskab m/3 skuffer, 1 toplade med trækgreb. Der er plads til skråfag i de 2 nederste skuffer. Fahrbarer Schrank m/3 Schubladen und 1 Abdeckplatte. Raum für Schrägfächer in den 2 unteren Schubladen. Mobile cabinet w/3 drawers, cabinet top w/pull handle. Space for inclined file trays in 2 drawers.</p>	<p>H 68,5 B 40 D/T 59,4</p>
100LS	 <p>Skuffeskab m/3 skuffer. Der er plads til skråfag i de 2 nederste skuffer. Schubladenschrank m/3 Schubladen. Raum für Schrägfächer in den 2 unteren Schubladen. Drawer cabinet w/3 drawers. Space for inclined file trays in 2 drawers.</p>	<p>H 58 B 40 D/T 58</p>
100JH	 <p>Mobil skuffeskab m/3 skuffer, 1 toplade med trækgreb. Der er plads til hængemapper i nederste skuffe. Fahrbarer Schrank m/3 Schubladen und 1 Abdeckplatte. Raum für Hängerordnerrahmen in den untere Schublade. Mobile cabinet w/3 drawers, cabinet top w/pull handle. Space for suspension file rack in the bottom drawer.</p>	<p>H 68,5 B 40 D/T 59,4</p>
100JS	 <p>Skuffeskab m/3 skuffer. Der er plads til hængemapper i nederste skuffe. Schubladenschrank m/3 Schubladen. Raum für Hängerordnerrahmen in den untere Schublade. Drawer cabinet w/3 drawers. Space for suspension file rack in the bottom drawer.</p>	<p>H 58 B 40 D/T 58</p>
100KH	 <p>Mobil skuffeskab m/2 skuffer og toplade med trækgreb. Der er plads til skråfag i øverste skuffe, og hængemapper i nederste skuffe. Fahrbarer Schrank m/2 Schubladen und 1 Abdeckplatte. Raum für Schrägfächer in 1. Schublade und Hängerordnerrahmen in den untere Schublade. Mobile cabinet w/2 drawers, cabinet top with pull handle. Space for inclined file trays in the top drawer and suspension file rack in the bottom drawer.</p>	<p>H 68,5 B 40 D/T 59,4</p>
100KS	 <p>Skuffeskab m/2 skuffer. Der er plads til skråfag i øverste skuffe og hængemapper i nederste skuffe. Schubladenschrank m/2 Schubladen. Raum für Schrägfächer in 1. Schublade und Hängerordnerrahmen in den untere Schublade. Drawer cabinet w/2 drawers. Space for inclined file trays in the top drawer and suspension file rack in the bottom drawer.</p>	<p>H 58 B 40 D/T 58</p>
100-2	<p>Centrallås i kabinet Zentralschloss im Schrank Central lock in cabinet</p>	<p>H B D/T</p>





Varenr. Warennr. Article nr.	Beskrivelse / Beschreibung / Description	Mål i cm Mass Measure
------------------------------------	--	-----------------------------

Skabe/reoler	Schränke/Regale	Cabinets/bookcases
--------------	-----------------	--------------------

171-33-30	 <p>Reol med stilbar hylde. Regalelement mit 1 verstellbaren Einlegeboden. Bookcase with 1 adjustable shelf.</p>	<p>H 74,1 B 30 D/T 33</p>
171-33-40	 <p>Reol med stilbar hylde. Regalelement mit 1 verstellbaren Einlegeboden. Bookcase with 1 adjustable shelf.</p>	<p>H 74,1 B 40 D/T 33</p>
171-33-50	 <p>Reol med stilbar hylde. Regalelement mit 1 verstellbaren Einlegeboden. Bookcase with 1 adjustable shelf.</p>	<p>H 74,1 B 50 D/T 33</p>
171-33-60	 <p>Reol med stilbar hylde. Regalelement mit 1 verstellbaren Einlegeboden. Bookcase with 1 adjustable shelf.</p>	<p>H 74,1 B 60 D/T 33</p>
171-33-80	 <p>Reol med stilbar hylde. Regalelement mit 1 verstellbaren Einlegeboden. Bookcase with 1 adjustable shelf.</p>	<p>H 74,1 B 80 D/T 33</p>
171-45-30	 <p>Reol med stilbar hylde. Regalelement mit 1 verstellbaren Einlegeboden. Bookcase with 1 adjustable shelf.</p>	<p>H 74,1 B 30 D/T 45</p>
171-45-40	 <p>Reol med stilbar hylde. Regalelement mit 1 verstellbaren Einlegeboden. Bookcase with 1 adjustable shelf.</p>	<p>H 74,1 B 40 D/T 45</p>
171-45-50	 <p>Reol med stilbar hylde. Regalelement mit 1 verstellbaren Einlegeboden. Bookcase with 1 adjustable shelf.</p>	<p>H 74,1 B 50 D/T 45</p>
171-45-60	 <p>Reol med stilbar hylde. Regalelement mit 1 verstellbaren Einlegeboden. Bookcase with 1 adjustable shelf.</p>	<p>H 74,1 B 60 D/T 45</p>
171-45-80	 <p>Reol med stilbar hylde. Regalelement mit 1 verstellbaren Einlegeboden. Bookcase with 1 adjustable shelf.</p>	<p>H 74,1 B 80 D/T 45</p>

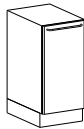
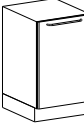
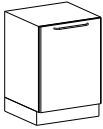
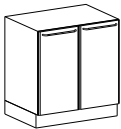
Varenr. Warennr. Article nr.	Beskrivelse / Beschreibung / Description	Mål i cm Mass Measure
172-35-30	 <p>Vægskab m/1 dør, 1 hylde. Wandschrank m/1 Tür, 1 Einlegeboden. Wall cabinet w/1 door, 1 shelf.</p>	<p>H 74,1 B 30 D/T 35</p>
172-35-40	 <p>Vægskab m/1 dør, 1 hylde. Wandschrank m/1 Tür, 1 Einlegeboden. Wall cabinet w/1 door, 1 shelf.</p>	<p>H 74,1 B 40 D/T 35</p>
172-35-50	 <p>Vægskab m/1 dør, 1 hylde. Wandschrank m/1 Tür, 1 Einlegeboden. Wall cabinet w/1 door, 1 shelf.</p>	<p>H 74,1 B 50 D/T 35</p>
172-35-60	 <p>Vægskab m/1 dør, 1 hylde. Wandschrank m/1 Tür, 1 Einlegeboden. Wall cabinet w/1 door, 1 shelf.</p>	<p>H 74,1 B 60 D/T 35</p>
172-35-80	 <p>Vægskab m/2 døre, 1 hylde. Wandschrank m/2 Türen, 1 Einlegeboden. Wall cabinet w/2 doors, 1 shelf.</p>	<p>H 74,1 B 80 D/T 35</p>
172-47-30	 <p>Vægskab m/1 dør, 1 hylde. Wandschrank m/1 Tür, 1 Einlegeboden. Wall cabinet w/1 door, 1 shelf.</p>	<p>H 74,1 B 30 D/T 47</p>
172-47-40	 <p>Vægskab m/1 dør, 1 hylde. Wandschrank m/1 Tür, 1 Einlegeboden. Wall cabinet w/1 door, 1 shelf.</p>	<p>H 74,1 B 40 D/T 47</p>
172-47-50	 <p>Vægskab m/1 dør, 1 hylde. Wandschrank m/1 Tür, 1 Einlegeboden. Wall cabinet w/1 door, 1 shelf.</p>	<p>H 74,1 B 50 D/T 47</p>
172-47-60	 <p>Vægskab m/1 dør, 1 hylde. Wandschrank m/1 Tür, 1 Einlegeboden. Wall cabinet w/1 door, 1 shelf.</p>	<p>H 74,1 B 60 D/T 47</p>
172-47-80	 <p>Vægskab m/2 døre , 1 hylde. Wandschrank m/2 Türen, 1 Einlegeboden. Wall cabinet w/2 doors, 1 shelf.</p>	<p>H 75 B 80 D/T 47</p>

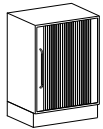
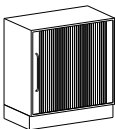
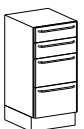
Varenr. Warennr. Article nr.	Beskrivelse / Beschreibung / Description	Mål i cm Mass Measure
173-47-40	 <p>Vægskab m/1 vitrinelåge, 1 hylde. Wandschrank m/1 Vitrinen Tür, 1 Einlegeboden. Wall cabinet w/1 glass door, 1 shelf.</p>	<p>H 74,1 B 40 D/T 47</p>
173-47-50	 <p>Vægskab m/1 vitrinelåge, 1 hylde. Wandschrank m/1 Vitrinen Tür, 1 Einlegeboden. Wall cabinet w/1 glass door, 1 shelf.</p>	<p>H 74,1 B 50 D/T 47</p>
173-47-60	 <p>Vægskab m/1 vitrinelåge, 1 hylde. Wandschrank m/1 Vitrinen Tür, 1 Einlegeboden. Wall cabinet w/1 glass door, 1 shelf.</p>	<p>H 74,1 B 60 D/T 47</p>
173-47-80	 <p>Vægskab m/2 vitrinelåger, 1 hylde. Wandschrank m/2 Vitrinen Türen, 1 Einlegeboden. Wall cabinet w/2 glass doors, 1 shelf.</p>	<p>H 74,1 B 80 D/T 47</p>
174-47-30	 <p>Underskab m/1 låge, 1 hylde. Unterschrank m/1 Tür, 1 Einlegeboden. Storage cabinet w/1 door, 1 shelf.</p>	<p>H 74,1 B 30 D/T 47</p>
174-47-40	 <p>Underskab m/1 låge, 1 hylde. Unterschrank m/1 Tür, 1 Einlegeboden. Storage cabinet w/1 door, 1 shelf.</p>	<p>H 74,1 B 40 D/T 47</p>
174-47-50	 <p>Underskab m/1 låge, 1 hylde. Unterschrank m/1 Tür, 1 Einlegeboden. Storage cabinet w/1 door, 1 shelf.</p>	<p>H 74,1 B 50 D/T 47</p>
174-47-60	 <p>Underskab m/1 låge, 1 hylde. Unterschrank m/1 Tür, 1 Einlegeboden. Storage cabinet w/1 door, 1 shelf.</p>	<p>H 74,1 B 60 D/T 47</p>
174-47-80	 <p>Underskab m/2 låger, 1 hylde. Unterschrank m/2 Türen, 1 Einlegeboden. Storage cabinet w/2 doors, 1 shelf.</p>	<p>H 74,1 B 80 D/T 47</p>
174-58-30	 <p>Underskab m/1 låge, 1 hylde. Unterschrank m/1 Tür, 1 Einlegeboden. Storage cabinet w/1 door, 1 shelf.</p>	<p>H 74,1 B 30 D/T 58</p>

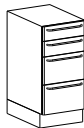
Varenr. Warennr. Article nr.	Beskrivelse / Beschreibung / Description	Mål i cm Mass Measure
174-58-40	 <p>Underskab m/1 låge, 1 hylde. Unterschrank m/1 Tür, 1 Einlegeboden. Storage cabinet w/1 door, 1 shelf.</p>	H 74,1 B 40 D/T 58
174-58-50	 <p>Underskab m/1 låge, 1 hylde. Unterschrank m/1 Tür, 1 Einlegeboden. Storage cabinet w/1 door, 1 shelf.</p>	H 74,1 B 50 D/T 58
174-58-60	 <p>Underskab m/1 låge, 1 hylde. Unterschrank m/1 Tür, 1 Einlegeboden. Storage cabinet w/1 door, 1 shelf.</p>	H 74,1 B 60 D/T 58
174-58-80	 <p>Underskab m/2 låger, 1 hylde. Unterschrank m/2 Türen, 1 Einlegeboden. Storage cabinet w/2 doors, 1 shelf.</p>	H 74,1 B 80 D/T 58
174-45J-50	 <p>Underskab med jalousilåge, 1 hylde. Unterschrank mit Rolladen Tür, 1 Einlegeboden. Lower cabinet with roll-front, 1 shelf.</p>	H 74,1 B 50 D/T 45
174-45J-60	 <p>Underskab med jalousilåge, 1 hylde. Unterschrank mit Rolladen Tür, 1 Einlegeboden. Lower cabinet with roll- front, 1 shelf.</p>	H 74,1 B 60 D/T 45
174-45J-80	 <p>Underskab med jalousilåge, 1 hylde. Unterschrank mit Rolladen Tür, 1 Einlegeboden. Lower cabinet with roll- front, 1 shelf.</p>	H 74,1 B 80 D/T 45
175-47-40	 <p>Skuffeskab m/4 skuffer. Der er plads til skråfag i de 2 nederste skuffer. Schubladen Schrank m/4 Schubladen. Raum für Schrägfächer in den 2 unteren Schubladen. Drawer cabinet w/4 drawers. Space for inclined file trays in the 2 bottom drawers.</p>	H 74,1 B 40 D/T 47
175-47-50	 <p>Skuffeskab m/4 skuffer. Schubladen Schrank m/4 Schubladen. Drawer cabinet w/4 drawers.</p>	H 74,1 B 50 D/T 47
175-58-40	 <p>Skuffeskab m/4 skuffer. Der er plads til skråfag i de 2 nederste skuffer. Schubladen Schrank m/4 Schubladen. Raum für Schrägfächer in den 2 unteren Schubladen. Drawer cabinet w/4 drawers. Space for inclined file trays in the 2 bottom drawers.</p>	H 74,1 B 40 D/T 58

Varenr. Warennr. Article nr.	Beskrivelse / Beschreibung / Description	Mål i cm Mass Measure
------------------------------------	--	-----------------------------

175-58-50



Skuffeskab m/4 skuffer.

Schubladen Schrank m/4 Schubladen.

Drawer cabinet w/4 drawers.

H 74,1

B 50

D/T 58

Indretning

Einrichtung

Arrangements

2

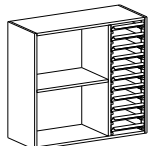

11 A4 blanketbakker indbygget i reol.

11 DIN A4 Schubfächer in Schrank eingebaut.

11 A4 form trays built in to cabinet.

H 74,1

B

D/T

Varenr. Warennr. Article nr.	Beskrivelse / Beschreibung / Description	Mål i cm Mass Measure
Diverse tilbehør	Verschiedene Zubehör	Additional Accessories
10.19H	Kabelgennemføring Ø 80 mm.Hvid Kabeldurchlass Ø 80 mm.Weiss Cable passage. Ø 80 mm. White.	H B D/T
10.19S	Kabelgennemføring Ø 80 mm.Sort Kabeldurchlass Ø 80 mm.Schwarz Cable passage. Ø 80 mm. Black.	H B D/T
10.19B	Kabelgennemføring Ø 80 mm. Børstet stål. Kabeldurchlass Ø 80 mm. Edelstahl. Cable passage Ø 80 mm. Stainless steel.	H B D/T
10.19-1H	Kabelgennemføring Ø 60 mm.Hvid Kabeldurchlass Ø 60 mm.Weiss Cable passage. Ø 60 mm. White.	H B D/T
10.19-1S	Kabelgennemføring Ø 60 mm.Sort Kabeldurchlass Ø 60 mm.Schwarz Cable passage. Ø 60 mm. Black.	H B D/T
10.19-1B	Kabelgennemføring Ø 60 mm. Børstet stål. Kabeldurchlass Ø 60 mm. Edelstahl. Cable passage Ø 60 mm. Stainless steel.	H B D/T
9018	A-shape benstel i lakeret stål. A-shape Beine in Stahl Lakeret. A-shape legs in lacquered steel.	H 720 B 700 D/T
9019	A-shape benstel i RAL 9005 sort. A-shape Beine in RAL 9005 Schwartz. A-shape legs in RAL 9005 black.	H 720 B 700 D/T
9020	Alu ben, fladovale 70-85 cm. Alu-beine, flachoval, 70-85 cm. Alu-legs, flatoval, 70-85 cm.	H 78 B D/T
9021	Stålbæn, krom. Stahlbein, chrom. Steel leg, chrome.	H 76 B D/T

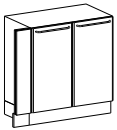
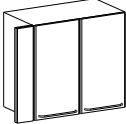
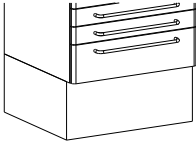
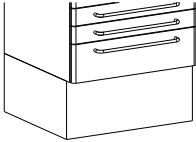
Varenr. Warennr. Article nr.	Beskrivelse / Beschreibung / Description	Mål i cm Mass Measure
9022	 <p>Tilpasningsstykke til underskabe Blende für Unterschränke Adjusting panel for cabinets</p>	<p>H 74,1 B D/T</p>
9023	 <p>Tilpasningsstykke til overskabe Blende für Wandschränke Adjusting panel for wall cabinets</p>	<p>H 74,1 B D/T</p>
2012	 <p>Alu sokkel pr. m. Alu Sockel, pro. m. Alu plinth per. m.</p>	<p>H 12 B D/T</p>
2013	 <p>Laminatsokkel, pr. meter Laminat-sockel, pro meter Lamainate plinth, per. Meter</p>	<p>H 12 B D/T</p>

danish healthcare design

Danish Healthcare
Design A/S
Drejøvej 8
9500 Hobro

+45 9851 1633
info@dhdas.dk
www.dhdas.dk
CVR nr. 64194615

climo